

ILLUSTRATED CATALOGUE.

M. MYERS & SON,

HARLOTTE STREET STEEL PEN WORKS,

BRITAIN

PATENTERS AND MANUFACTURERS

OF

STEEL PENS, PENHOLDERS

REMNANTS & GASSES;

LETTER CLIPS, ELASTIC

PAPER BINDERS

AND

STATIONERS

JOHN GATTEY, ENGRAVER

M. MYERS & SON'S PATENT METALLIC PENS.













Selection of useful Patterns for General Purposes.

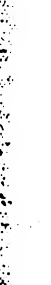





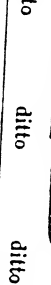
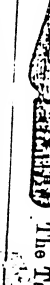

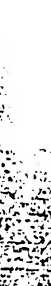
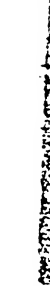

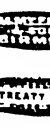

No.	Material	Illustration	Description	Quality	Price
3106	Bronze		School Pen, Plain	Good Quality	6d.
			Shoulder Pen, Plain	Best Quality	8d.
			Shoulder Office Pen, Strong	Good Quality	7d.
3099	Bronze		Commercial J Pen	Best Quality	1/-
3051	Bronze		Selected G Pen	Best Quality	8d.
431	Bronze		Fique Pen	Best Quality	9d.
			Pen	Best Quality	9d.
			Pen	Best Quality	9d.
			Pen	Best Quality	9d.

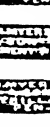

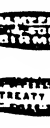



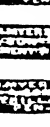

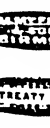
Wm. G. Wainwright & Co. Birmingham.

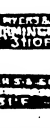
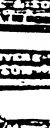

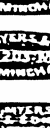

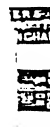
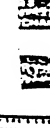
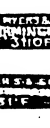
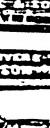

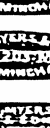

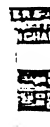
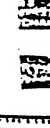
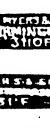
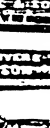

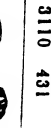
STEEL PENS.—Continued.

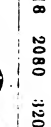
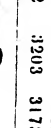
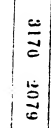

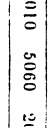
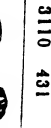

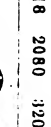
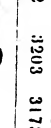
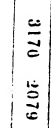
Selection of useful Patterns for General Purposes.

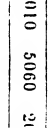
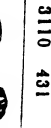
188		Counting House Pen	1/2
189		The Celebrated American Falcon Pen. This is acknowledged to be the best general purpose Pen in the market, and has a very large sale	9/1d.
186		The Seven Star Pen	9/1d.
187		The Classical Pen	1/0
182		Curved Point Pen	9/1d.
181		Mountain Pen	9/1d.
180		Mountain Spear Pen	11d.
179		Alexandre Von Humboldt Cement Pen	11d.
178		School Pen	9d.
177		Patent Galvanized Giant Pen	9d.
176		Patent Galvanized Shell-Gold Pen	9d.
175		Patent Galvanized Shoulder Pen	9d.
174		First-Class Pen	10d.
173		The Jerusalem Pen	11d.
172		The Palmyra Pen	11d.
171		Prince of Wales Pen	11d.
170		Charlotte Street Steel Pen	11d.

3056		Penna Pen	6/8
3189		Treaty Pen	6/8
5088		Birmingham Pen	6/8
5089		Birmingham Pen	6/8
161		Birmingham Pen	6/8
3011		Birmingham Pen	6/8
2028		Birmingham Pen	6/8
1020		Birmingham Pen	6/8
3186		Birmingham Pen	6/8
2036		Birmingham Pen	6/8
68		Birmingham Pen	6/8
3171		Birmingham Pen	6/8
3030		Birmingham Pen	6/8
2089		Birmingham Pen	6/8
052		Birmingham Pen	6/8
222		Birmingham Pen	6/8

3110		Bullion Pen	4/1
431		Bullion Pen	4/1
432		Bullion Pen	4/1
14/4		Bullion Pen	4/1
3018		Bullion Pen	4/1
2080		Bullion Pen	4/1
3202		Bullion Pen	4/1
3203		Bullion Pen	4/1
3173		Bullion Pen	4/1
3170		Bullion Pen	4/1
2079		Bullion Pen	4/1
41		Bullion Pen	4/1
8		Bullion Pen	4/1
1010		Bullion Pen	4/1
5060		Bullion Pen	4/1
202		Bullion Pen	4/1

3110		Bullion Pen	4/1
431		Bullion Pen	4/1
432		Bullion Pen	4/1
14/4		Bullion Pen	4/1
3018		Bullion Pen	4/1
2080		Bullion Pen	4/1
3202		Bullion Pen	4/1
3203		Bullion Pen	4/1
3173		Bullion Pen	4/1
3170		Bullion Pen	4/1
2079		Bullion Pen	4/1
41		Bullion Pen	4/1
8		Bullion Pen	4/1
1010		Bullion Pen	4/1
5060		Bullion Pen	4/1
202		Bullion Pen	4/1

27 N		Charlotte Street Steel Pen	2035
027 N		Charlotte Street Steel Pen	2068
04158		Charlotte Street Steel Pen	27
3085		Charlotte Street Steel Pen	0027

STEEL PENS.—Continued.

SELECTION OF USEFUL PATTERNS FOR GENERAL PURPOSES.

FOR ILLUSTRATIONS, SEE PAGE 41

1/11	10d.	1/2	1/2	10d.	10d.	10d.	9d.
3056	3189	5088	5089	164	3011	2028	1020
White	Bronze	Bronze	Tinted	Bronze	Bronze	Tinted	Tinted
9d.	11d.	2/-	11d.	10d.	10d.	9d.	8d.
3186	20368	68	3171	3010	2089	0628	222
Grey	White		Grey	Grey	White	Grey	Grey
11d.	8d.	8d.	94d.	11d.	94d.	1/-	1/-
410	431	432	14/18	3018	2080	3202	3203
Grey	Bronze	Bronze	Bronze	Grey	Bronze	Grey	Grey
1/11	8d.	10d.	8d.	8d.	73d.	8d.	9d.
3173	3170	2079	44	8	1010	5060	2029
Bronze	Bronze	Grey	Bronze	Tinted	Bronze	Tinted	White
1/4	8d.	8d.	8d.	8d.	8d.	3/4	6d.
171	3086	031A	031B	031C	031D	5062	0128
Grey	Tinted	Per	F	N	H		
2/8	2/1	2/8	2/4	2/-	1/4	1/4	1/4
6062	6031	631	Q2010	G112	E3043	P112	P5081
Gilt	Gilt	D.G.	Gilt	Gilt	Gilt	Gilt Pt.	Gilt Pt.
							P176
							Gilt Pt.

MAGNUM BONUM PENS.

(FOR ILLUSTRATIONS, SEE PAGE 41)

2/8	3/-	3/4	4/-	1/4	2/-	3/-	per Gross.
27N	027N	04475S	3085	2068	27	0027	in Boxes of 1 dozen, with Holder.
			1/6				2035 in Boxes of 3 dozen, with Holder.

All Pens may be had in E.P., F., M., or B Points.

PATENT SKELETON PEN.

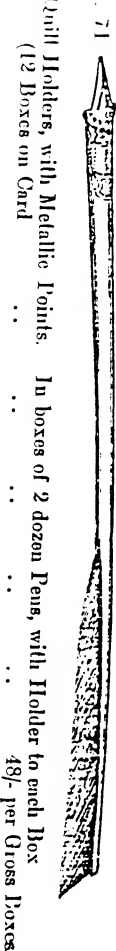

Quill Holders, with Metallic Points. In boxes of 2 dozen Pens, with Holder to each Box (12 Boxes on Card) ... 48/- per Gross Boxes.

Extract from "ILLUSTRATED LONDON NEWS":
 "Improved Steel Pens.—One of the most general objections to the use of Steel Pens is their extreme fragility, a defect which has been effectually prevented in the 'Skeleton' or Metallic Points for Quill Pens, patented by M. Myers & Son, in which the ease and comfort of the Quill is combined with the durability of the Steel Pen."

Charlotte Street Steel Pen Works, Birmingham.

FANCY BOXES OF STEEL PENS.

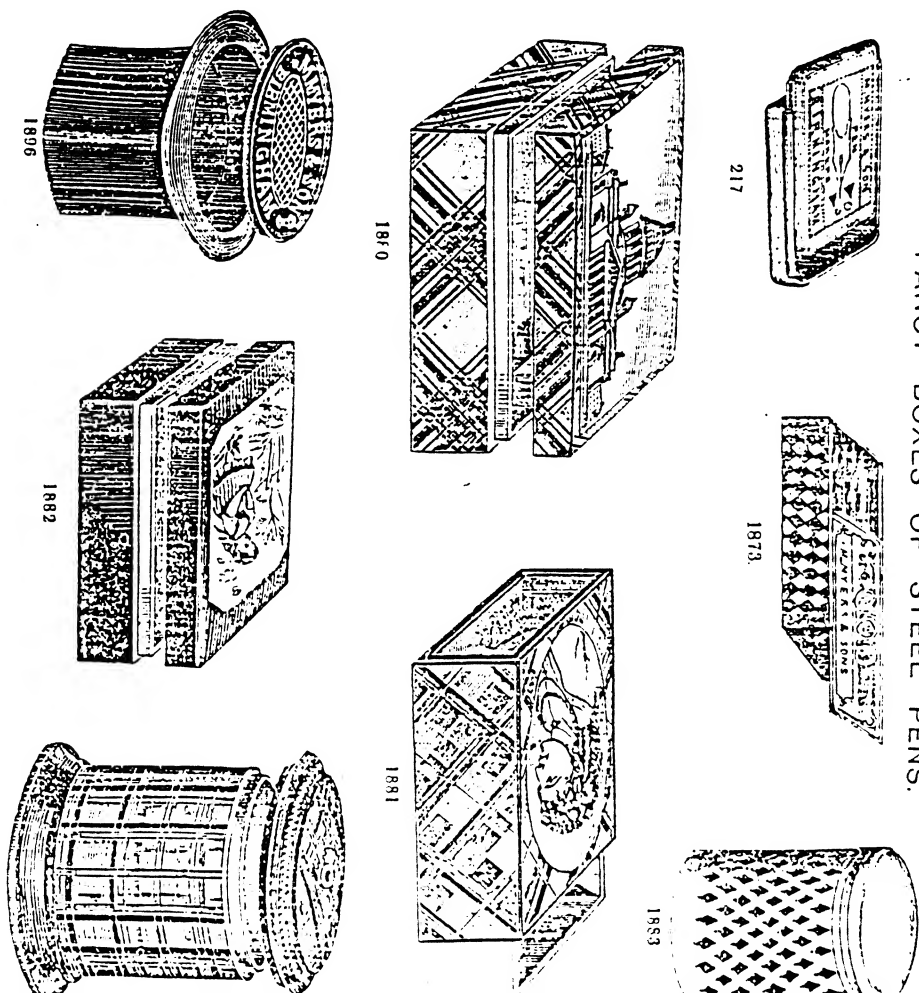

- 1876 Round Ornamental Tin Box, containing 1 dozen Pens, 3 dozen Boxes on Card
- 1874 Flat Brass Box, containing 1 dozen Pens, 3 dozen boxes on Card
- 244 Flat Box, Gold or Silver color, Sliding Lid, with 1 dozen Pens, in Cartoons of 1 gross
- 217 Superior Quality Flat Box, Gold color, Sliding Lid, containing 1 dozen Pens, on Cards of 2 dozen
- 1873 Flat Ornamental Tin Box, Sliding Lid, containing 3 dozen Pens, assorted patterns, 12 Boxes on Card
- 1875 Tartan Wood Box, round, containing 1 dozen Gilt Pens, in Cartoons of 1 dozen
- 1877 Tartan Wood Box, round, containing 1 gross good Steel Pens
- 1879 Tartan Wood Box, round, with Brush, containing 1 gross good Steel Pens

Charlotte Street Steel Pen Works, Birmingham.

FANCY BOXES OF STEEL PENS—Continued.

1	Italian Wood Box, square, containing 1 gross Pens	20/-
2	Italian Wood Box, square, to slide, with colored Pictur, containing 100 Pens	16/-
3	Polished Metal Box, Nickel-plated, containing 3 dozen Pens	8/-
4	Prince of Wales Pen, 2 dozen in Slide Box, with Photograph, 1 dozen Boxes in case	4/-
5	Prince Imperial Pen, 2 dozen in Slide Box, with Photograph, 1 dozen Boxes in case	4/-
6	Celebrated J Pen, 1 dozen in Slide Box, 1 dozen Boxes on Card	24/-
7	Selected G Pen, 1 dozen in Slide Box, 1 dozen Boxes on Card	24/-
8	Shoulder Pen, 1 dozen in Slide Box, 1 dozen Boxes on Card	24/-
9	Celebrated J Pen, 3 dozen in Slide Box, 12 Boxes in Case	48/-
10	Selected G Pen	48/-
11	Shoulder Pen	48/-
12	Seven Star Pen	48/-
13	Celebrated American Falcon Pen, 3 dozen in Slide Box, 12 Boxes in Case	48/-
14	Golden Mountain Pen, 2 dozen in Slide Box, 12 Boxes in Case	48/-
15	Bullion Pen, 1 dozen in Slide Box, 1 dozen Boxes in Case	48/-
16	Metal Box—Hat Sharp, containing 1 gross Pens "A Hat full of Pens for 1/-"	96/-

(FOR ILLUSTRATIONS, SEE PAGE 61)

MAPPING BARREL PENS.

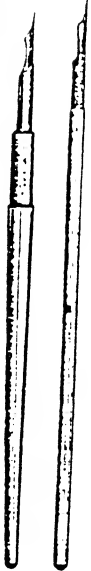

62A	Mapping Pens, 3 dozen in Box, with 3 Holders	3/4
62B	Ditto	4/-
62C	Ditto	5/4
62D	Ditto	6/-
62E	Ditto	6/-
62F	Ditto	7/4
62G	Ditto	8/-

Charlotte Street Steel Pen Works, Birmingham.

M. MYERS & SON'S PATENT & OTHER PENHOLDERS

No. 162 Sliding Holder



No. 766 Biting Holder



No. 109 Biting Holder



No. 135



No. 463

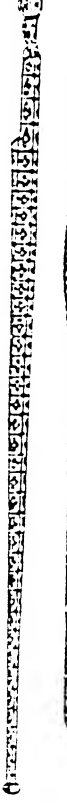

No. 621



No. 2021P



No. 210



All Penholders measured Full Length, including Tip.

No.	Description	Per Gross	Per Doz.
754	5 1/2-in. Accommodation School Penholder, coloured fluted handle, good tip	1/2	1/-
16	ditto	1/4	1/-
17	6-in. ditto	1/2	1/-
18	6-in. ditto	1/2	1/-
4	6-in. ditto	1/2	1/-
4D	6 1/2-in. ditto	1/2	1/-
735	9-in. Coloured Paper Holder, good tip	1/2	2/-
4T	ditto	1/2	2/-
547	9-in. ditto	1/2	2/-
274	5 1/2-in. Imitation Cedar Handle, steel split tip	1/2	2/-
560	6-in. ditto	1/2	2/-
533	6-in. ditto	1/2	2/-
138	6-in. ditto	1/2	2/-
313	7-in. ditto	1/2	2/-
199	6 1/2-in. ditto	1/2	2/-
534	6-in. Junination Ebony Twisted Handle, strong steel binding tip	1/2	3/-
525	7-in. Ditto	1/2	3/-
530	9-in. Ditto	1/2	3/-

PENHOLDERS—Continued.

No.	Size	Description	Per One Doz.	Per One Doz. Based on
549	9-in.	Inflation Cedar Taper Twisted strong steel binding tip with stop	3/1	2/1
285	6-in.	Real Cedar Holder, smooth, steel split tip	2/1	2/8
291	6-in.	Ditto binding steel tip, galvanized, with stop	2/8	6/8
544	6-in.	Polished Wood Holder, swelled centre, strong binding steel tip	4/-	3/4
652	7-in.	Ditto thick, swelled centre, strong steel spring tip	6/8	3/4
258	6-in.	Real Cedar Fluted Holder, steel spring tip	3/4	3/1
127	6-in.	Ditto Twisted Holder, binding steel tip	3/1	4/-
311	7-in.	Ditto Taper Holder, steel split tip	3/1	6/-
315	9-in.	Ditto ditto	4/-	3/9
136	6-in.	Ditto Twisted Holder, gilt tip	6/-	4/1
325	7-in.	Ditto Taper Holder, binding steel stop tip	3/9	4/1
527	7-in.	Ditto Taper Twisted Holder, steel-spring tip	4/1	4/8
260	9-in.	Ditto Taper Thin Holder, binding steel tip with stop	4/1	4/8
265	9-in.	Ditto Taper Twisted Holder, ditto	4/1	5/-
526	9-in.	Ditto Taper Fluted Holder, steel spring tip	4/8	6/8
226	7-in.	Ditto Taper Twisted Holder, thick strong steel tip	5/-	16/-
327	7-in.	Ditto Taper Twisted Holder, thick strong steel tip	6/8	8/-
319	6-in.	Ditto Anti-Blocking Holder, French Pattern	8/-	16/-
135	6-in.	Ditto ditto, superior quality, swelled centre, gilt tip	12/-	16/-
135A	6-in.	Ditto ditto, on cards, with gilt pens	12/-	8/-
2610	7-in.	Emannelled Holder, assorted colors, brass tip with stop	16/-	8/-
5640	7-in.	Ditto ditto gilt tip	8/-	10/8
591	7-in.	Black Emannelled Holder, silver spring tip, gilt pen	10/8	13/4
592	7-in.	Ditto ditto	13/4	16/-
621	7-in.	Ditto fancy silver tip and gilt pen	16/-	280
622	7-in.	Ditto ditto	16/-	780
281	7-in.	Rosewood Taper Holder, galvanized steel stop tip	6/8	79
239	6-in.	Ditto brass stop tip	7/4	106
171	6-in.	Ditto gilt steel spring tip	7/4	162
300	7-in.	Ditto thick, strong steel spring tip	12/-	13/4
287	7-in.	Ditto superior gilt steel spring tip	13/4	16/-
170	6-in.	Scottish Maid Holder, brass accommodation tip	5/4	24/-
419	9-in.	Scottish Maid Taper Holder, brass tip with stop	6/8	6/8
165	6-in.	Scottish Maid Taper Holder, brass tip with stop	9/4	10/8
207	6-in.	Ditto gilt steel tip	9/4	767
452	6-in.	Ditto gilt spring tip	6/8	768
230	7-in.	Ditto taper, brass tip with stop	13/4	108
166	9-in.	Ditto taper, brass tip with stop	10/8	109
151	9-in.	Ditto taper, gilt patent spring tip	12/-	111
559	6-in.	Ditto taper, swelled, gilt spring tip and gilt pen	20/-	112
202	8-in.	Ditto taper, swelled, gilt binding tip with stop, gilt pen	26/8	110
202A	8-in.	Ditto taper, with photograph	32/-	107
417	8-in.	Whitewood Swelled Taper Holder, with viows, gilt binding tip and pen	32/-	113
416	8-in.	Scottish Touran Holder, very thick, strong gilt spring tip and pen	42/8	114
210	8-in.	Ditto with photograph	48/-	
322	8-in.	Whitewood ditto with viows	48/-	
769	6-in.	Floral Holder, gilt binding stop tip with gilt pen	48/-	
770	6-in.	Ditto brass tip	13/4	
128	6-in.	Fancy Pattern Paper Holder, brass tip, very pretty	8/-	639
213	4-in.	Bone Taper, plain, galvanized steel tip and pen	6/4	610
214	5-in.	Ditto plain, brass tip	8/8	627
699	5-in.	Ditto plain, steel strong tip	8/-	628
276	5-in.	Ditto fancy, brass tip with stop	8/-	629
216	5-in.	Ditto plain, brass tip with stop	10/-	302
			13/4	14/8

Charlotte Street Steel Pen Works, Birmingham

PENHOLDERS—Continued.

No.	Size	Description	Per One Doz.	Per One Doz. Based on
208	6-in.	Bone Taper, plain, gilt steel tip and pen	16/-	17/4
275	6-in.	Ditto swelled, brass tip and pen	17/4	18/-
267	6-in.	Ditto fancy, brass tip and pen	22/8	20/-
447	6-in.	Ditto fancy, gilt spring tip and pen	20/-	20/-
351	6-in.	Ditto fancy, gilt spring tip and pen	20/-	20/-
398	6-in.	Ditto swelled, gilt spring tip and pen	20/-	20/-
253	7-in.	Ditto fancy, brass stop tip and pen	22/8	33/4
400	8-in.	Ditto balance, gilt spring tip and gilt pen	33/4	16/-
654	6-in.	Ditto plain, fancy gilt star tip and gilt pen	18/-	18/-
655	6-in.	Ditto plain, fancy silver star tip and gilt pen	22/8	25/4
613	6-in.	Ditto fancy, gilt star tip and gilt pen	25/4	26/8
656	8-in.	Ditto fancy, silver star tip and gilt pen	26/8	24/-
657	8-in.	Ditto gilt star tip and gilt pen	24/-	24/-
750	5-in.	Ditto plain, nickel-plated tip, engine-turned, and gilt pen	24/-	32/-
746	5-in.	Ditto plain, nickel-plated tip, engine-turned, and gilt pen	32/-	39/-
751	6-in.	Ditto swelled, nickel-plated tip, engraved, and gilt pen	39/-	39/-
752	6-in.	Ditto plain, nickel-plated tip, engraved, and gilt pen	39/-	39/-
753	6-in.	Ditto plain, nickel-plated tip, engraved, and gilt pen	39/-	39/-
748	7-in.	Ditto plain, nickel-plated tip, engraved, and gilt pen	39/-	39/-
744	7-in.	Ditto swelled, nickel-plated tip, engraved, and gilt pen	39/-	39/-
102	6-in.	Ditto plain, long gilt metal tip, engraved, gilt pen	39/-	39/-
103	6-in.	Ditto ditto	39/-	39/-
104	6-in.	Ditto ditto	39/-	39/-
105	7-in.	Ditto ditto	39/-	39/-
280	7-in.	Ditto swelled, ditto	39/-	39/-
779	7-in.	Ditto swelled, ditto	39/-	39/-
106	7-in.	Ditto fancy, ditto	39/-	39/-
162	6-in.	Ditto plain, with engraved german silver tip, to slide	39/-	39/-

PENHOLDERS, with Ejecting Tips.

1313	7-in.	Black Emannelled Holder, nickel-plated engraved ejecting tip, gilt pen	32/-	24/-
766	6-in.	Polished Wood Holder, plated ejecting tip and pen	32/-	32/-
767	4-in.	Ditto ditto	32/-	32/-
768	4-in.	Bone Taper ditto	32/-	32/-
108	6-in.	Ditto ditto	32/-	32/-
109	6-in.	Ditto long gilt ejecting tip, gilt pen	32/-	32/-
111	6-in.	Ditto ditto	32/-	32/-
112	6-in.	Ditto swelled, ditto	32/-	32/-
110	6-in.	Ditto ditto	32/-	32/-
107	7-in.	Ditto ditto	32/-	32/-
113	7-in.	Ditto ditto	32/-	32/-
114	7-in.	Ditto swelled ditto	32/-	32/-

PORCUPINE QUILL PENHOLDERS.

639	7 1/2 to 9-in.	Porcupine Quill Holder, gilt steel tip and pen	16/-	24/-
610	8 1/2 to 10-in.	Ditto ditto	18/-	32/-
627	9 to 10-in.	Ditto long fancy metal tip, silver and gilt pen	48/-	48/-
628	10 to 12-in.	Ditto fine large quills	18/-	18/-
629	10 to 12-in.	Ditto gilt tip, fine large quills	18/-	18/-
302	10 to 12-in.	Ditto long gilt metal tip, engraved, gilt pen	18/-	18/-

Charlotte Street Steel Pen Works, Birmingham.

METAL PENHOLDERS.

Decorated Tin Reversible Holder	Per Doz.	Per Doz.
Ditto	3/-	4/-
Ditto with rubber and measure	3/8	4/1
Ditto with pen and pencil	9/-	7/-
Nickel-plated Penholder, assorted patterns, gilt pen. A very nice present	5/1	6/8
G.S. Telescope, reversible, for the pocket		4/8
Ditto engraved		32/-
		40/-

SUPERIOR PRESENTATION PENHOLDERS,
with Sterling Silver Tips.

4 1/2-in. Pearl Handle, engraved silver tip	Per Doz.
5-in. Ditto engine-turned silver tip	17/-
5 1/2-in. Ditto hexagon, engraved silver tip	21/-
5 1/2-in. Ditto round, engraved silver tip	22/8
6 1/2-in. Ditto very fine, round, engraved silver tip	25/8
6 1/2-in. Ditto round, engine-turned silver tip	38/8
6-in. Ditto round, engine-turned silver tip	16/-
6 1/2-in. Ditto large hexagon, engraved silver tip	19/4
6 1/2-in. Ditto large fluted, silver tip	24/-
4 1/2-in. Agate round, engraved with mount on top	95/8
7 1/2-in. Ditto assorted colors, round, engraved tip	25/8
7 1/2-in. Porcupine Quill, round, engraved silver tip and top mount	40/-
7 1/2-in. Ditto round, engraved silver tip and top mount	9/4
8-in. Ditto hexagon, engraved silver tip and top mount	11/4
8-in. Ditto round, engraved silver tip and top mount	14/8
9-in. Ditto hexagon, engraved, silver tip and top mount	14/-
9 1/2-in. Ditto round, engine-turned	18/-
	19/-

PENHOLDERS, ASSORTED (On Cards).

4 1/2-in. White Bone Holder, taper, with galvanized steel tip and pen	Per Doz.
5-in. Ditto black steel tip and pen	8/-
Assorted Tartan, Wood, and Fancy Paper Holders, with brass tips and pens	8/-
Ditto Wood Holders, swelled centres, steel tips and pens	6/8
Ditto Fancy Holders, with brass tips and pens	6/-
Ditto Tartan, Cedar, and Fancy Wood Holders, brass tips and pens	7/1
Ditto Tartan, Cedar, Bone, and Fancy Wood Holders, brass tips and pens	8/-
Ditto Tortan, Cedar, Bone, and Fancy Wood Holders, with best gilt tips and pens	8/-
Ditto Ebony, Rosewood, and Bone Holders, with silvered tips and pens	16/-
Ditto Black Enameled Holders, with gilt and silvered tips and pens	16/-
5-in. Bone Holders, swelled centres, with gilt and silvered tips and pens	16/-
5-in. Bone Taper, silvered star tips and gilt pens	16/-
Assorted Bone and Porcupine Holders, with gilt tips and pens	16/-
6 1/2-in. Bone Holders, assorted plain and fancy, with gilt tips and pens	24/-
7-in. Bone Tapers, fancy gilt tips and pens	24/-
7 1/2-in. Bone Tapers, with fine engraved gilt tips and pens	32/-
	48/-

Charlotte Street Steel Pen Works, Birmingham.

ALUMINIUM GOLD PENCILS.

(For Description, &c., see Pages 14 & 15.)

No. 53

No. 58

No. 60

No. 66

No. 80

No. 88

No. 203

No. 219

No. 232

Charlotte Street Steel Pen Works, Birmingham.

ALUMINIUM GOLD PENCILS.

(For Description, &c., see Pages 14 & 15.)

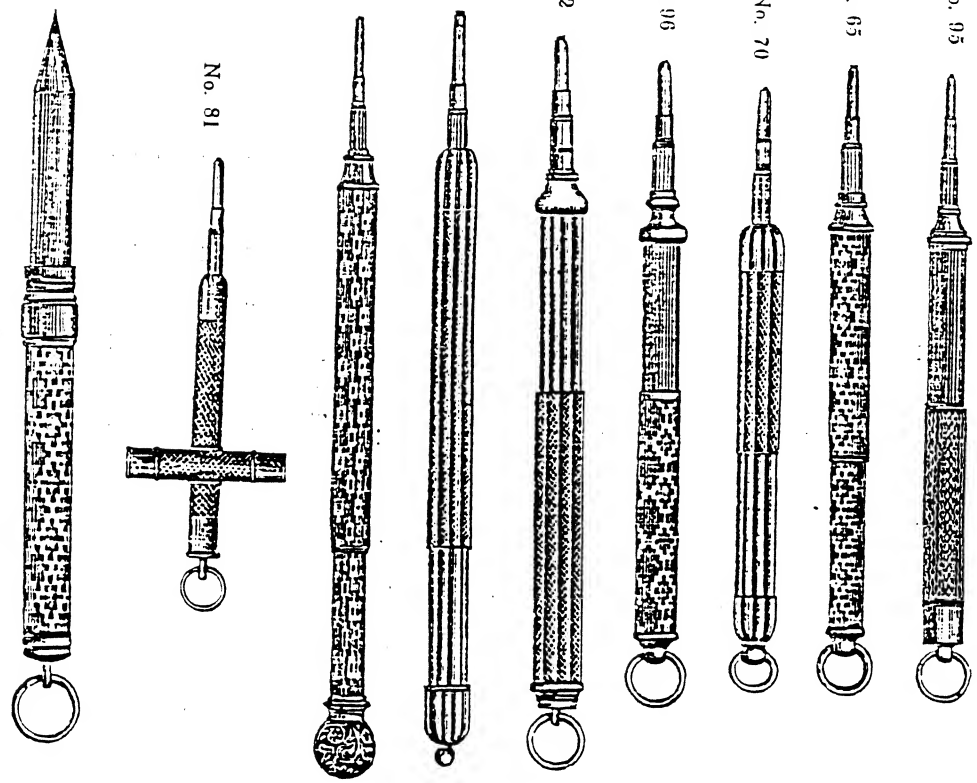

Charlotte Street Steel Pen Works, Birmingham.

ALUMINIUM GOLD PENCILS.

Manufactured of the finest Aluminium Gold, sustaining a high finish, very strong and durable, and presenting a rich appearance.

(FOR ILLUSTRATIONS, SEE PAGES 12 & 13.)

No.	Description	Price	Weight
No. 69	Spiral, engine-turned	10/8	10/8
No. 84	Ditto	12/-	12/-
No. 235	Ditto	13/1	13/1
No. 86	Ditto with reserve	11/1	11/1
No. 236	Ditto with reserve	14/-	14/-
No. 63	Ditto	14/8	14/8
No. 65	Ditto	16/-	16/-
No. 66	Ditto	15/-	15/-
No. 67	Ditto	16/-	16/-
No. 68	Spiral, twisted	15/8	15/8
No. 98	Ditto cable pattern	20/-	20/-
No. 227	Ditto black enamelled	16/-	16/-
No. 90	Ditto engine-turned	14/-	14/-
No. 66	Ditto twisted	13/4	13/4
No. 67	Ditto ditto	16/-	16/-
No. 97	Ditto cable pattern	16/-	16/-
No. 61	Ditto engine-turned	13/-	13/-
No. 234	Ditto ditto	16/-	16/-
No. 77	Ditto black enamelled	16/-	16/-
No. 237	Ditto ditto	16/-	16/-
No. 83	Ditto engine turned, with reserve	19/8	19/8
No. 66	Pull-out ditto and reserve	15/-	15/-
No. 94	Ditto black enamelled, and reserve	15/-	15/-
No. 223	Ditto ditto seal head	16/-	16/-
No. 203	Ditto engine-turned, spiral	17/1	17/1
No. 244	Ditto ditto	16/-	16/-
No. 219	Match Chain Bar Pen, engine-turned, spiral	16/-	16/-
No. 220	Ditto ditto	16/-	16/-
No. 233	Ditto ditto	16/-	16/-
No. 232	Ditto ditto	16/-	16/-
No. 241	Ditto ditto	16/-	16/-
No. 215	Ditto ditto	16/-	16/-
No. 216	Ditto ditto	16/-	16/-
No. 217	Ditto ditto	16/-	16/-
No. 226	Ditto ditto	16/-	16/-
No. 248	Ditto ditto	16/-	16/-
No. 258	Ditto ditto	16/-	16/-
No. 259	Ditto ditto	16/-	16/-
No. 60	Small Charlem Pen, engine-turned, spiral	18/-	18/-
No. 243	Double-motion, engine-turned, no reserve	20/-	20/-
No. 62	Ditto ditto	33/4	33/4
No. 63	Ditto ditto	32/-	32/-
No. 64	Ditto ditto	32/-	32/-
No. 213	Ditto ditto	33/4	33/4

Charlotte Street Steel Pen Works, Birmingham.

ALUMINIUM GOLD PENCILS—Continued.

No.	Description	Per Doz.
61	Double-action, damask, engine-turned, with reserve, ball top	36/-
62	Ditto black enamelled, ditto	33/4
63	Ditto damask, with ring	32/-
64	Ditto engine-turned ditto	32/-
65	Ditto plain ditto	32/-
66	Ditto black enamelled ditto	32/-
67	Ditto black enamelled ditto	32/-
68	Ditto engine-turned, with ball top and ring	31/-
69	Ditto gothic, with ring	36/-
70	Ditto silver aluminium mount, with ring	39/-
71	Ditto pearl, with ring	36/-
72	Ditto pearl, with ring	36/-
73	Ditto from the front, engine-turned, with ring	70/-
74	Ditto ditto damask ditto	75/-
75	Ditto ditto gothic ditto	33/4
76	Ditto ditto engine-turned ditto	33/4
77	Ditto ditto ditto ditto	28/-
78	Ditto engine-turned, with swivel reserve	32/-
79	Ditto Slide Pen, with hand and reserve	36/-
80	Ditto Ditto with hand and swivel	16/-
81	Ditto Ditto Case, damask, with ring; cedar pencil	16/-
82	Ditto Spiral and elongating, engine-turned	16/-
83	Ditto Spiral Pen, and Slide Penholder at other end	18/8
84	Ditto Ditto ditto ditto	24/-
85	Ditto Ditto ditto ditto	30/-
86	Ditto Ditto ditto ditto	27/-
87	Ditto Telescope Pen and Pen, damask	40/-
88	Ditto Magic ditto ditto	32/-
89	Ditto Elongating Spiral Pen and Pen, engine-turned, with reserve	53/4
90	Ditto Pen, Pen and Knife, engine-turned	48/-
91	Ditto Spiral Pen and Knife, engine-turned	44/-
92	Ditto Telescope Magic, with ring, damask, strong, length open 5 1/2-in., closed 2 1/2-in.	44/-
93	Ditto Ditto ditto plain ditto	54/-
94	Ditto Spiral Pen and Cigar Cutter, engine-turned	54/-
95	Ditto Ditto Gross, with ring, engine-turned	30/-
96	Ditto Ditto Canon, with ring, plain	20/-
97	Ditto Pocket Book Pen, 4-in. engine-turned	30/-
98	Ditto Ditto ditto 3 1/2-in.	11/8
99	Ditto Ditto ditto ditto	10/8

Charlotte Street Steel Pen Works, Birmingham.

STERLING SILVER PENCILS.

No. 100
No. 101
No. 102

No.	Description	Per Doz.
100	Spiral, with reserve, engine-turned	20/-
101	Ditto " " gothic pattern	21/-
102	Ditto " " lady's, thin	16/-
103	Ditto " " with ring, engraved, small charm	16/-
104	Ditto " " telescopic	10/-
105	Sliding Pen, with ring, engine-turned	18/-
106	Double-action Spiral, with ring, engine-turned	30/-
107	Ditto Ditto plain	36/-
108	Ditto " " with reserve, engine-turned	38/-
109	Ditto " " large diameter	36/-
110	Ditto " " with handsome chased seal head	40/-
111	Ditto " " with handsome chased seal head	54/-
112	Ditto " " with handsome chased seal head	36/-
113	Ditto " " with handsome chased seal head	54/-
114	Ditto " " with handsome chased seal head	54/-
115	Ditto " " with handsome chased seal head	54/-
116	Ditto " " with handsome chased seal head	54/-
117	Ditto " " with handsome chased seal head	54/-
118	Ditto " " with handsome chased seal head	54/-
119	Ditto " " with handsome chased seal head	54/-
120	Ditto " " with handsome chased seal head	54/-
121	Ditto " " with handsome chased seal head	54/-
122	Ditto " " with handsome chased seal head	54/-
123	Ditto " " with handsome chased seal head	54/-
124	Ditto " " with handsome chased seal head	54/-
125	Ditto " " with handsome chased seal head	54/-
126	Ditto " " with handsome chased seal head	54/-
127	Ditto " " with handsome chased seal head	54/-
128	Ditto " " with handsome chased seal head	54/-
129	Ditto " " with handsome chased seal head	54/-
130	Ditto " " with handsome chased seal head	54/-
131	Ditto " " with handsome chased seal head	54/-
132	Ditto " " with handsome chased seal head	54/-
133	Ditto " " with handsome chased seal head	54/-
134	Ditto " " with handsome chased seal head	54/-
135	Ditto " " with handsome chased seal head	54/-
136	Ditto " " with handsome chased seal head	54/-
137	Ditto " " with handsome chased seal head	54/-
138	Ditto " " with handsome chased seal head	54/-
139	Ditto " " with handsome chased seal head	54/-
140	Ditto " " with handsome chased seal head	54/-
141	Ditto " " with handsome chased seal head	54/-
142	Ditto " " with handsome chased seal head	54/-
143	Ditto " " with handsome chased seal head	54/-
144	Ditto " " with handsome chased seal head	54/-
145	Ditto " " with handsome chased seal head	54/-
146	Ditto " " with handsome chased seal head	54/-
147	Ditto " " with handsome chased seal head	54/-
148	Ditto " " with handsome chased seal head	54/-
149	Ditto " " with handsome chased seal head	54/-
150	Ditto " " with handsome chased seal head	54/-
151	Ditto " " with handsome chased seal head	54/-
152	Ditto " " with handsome chased seal head	54/-
153	Ditto " " with handsome chased seal head	54/-
154	Ditto " " with handsome chased seal head	54/-
155	Ditto " " with handsome chased seal head	54/-
156	Ditto " " with handsome chased seal head	54/-
157	Ditto " " with handsome chased seal head	54/-
158	Ditto " " with handsome chased seal head	54/-
159	Ditto " " with handsome chased seal head	54/-
160	Ditto " " with handsome chased seal head	54/-
161	Ditto " " with handsome chased seal head	54/-
162	Ditto " " with handsome chased seal head	54/-
163	Ditto " " with handsome chased seal head	54/-
164	Ditto " " with handsome chased seal head	54/-
165	Ditto " " with handsome chased seal head	54/-
166	Ditto " " with handsome chased seal head	54/-
167	Ditto " " with handsome chased seal head	54/-
168	Ditto " " with handsome chased seal head	54/-
169	Ditto " " with handsome chased seal head	54/-
170	Ditto " " with handsome chased seal head	54/-
171	Ditto " " with handsome chased seal head	54/-
172	Ditto " " with handsome chased seal head	54/-
173	Ditto " " with handsome chased seal head	54/-
174	Ditto " " with handsome chased seal head	54/-
175	Ditto " " with handsome chased seal head	54/-
176	Ditto " " with handsome chased seal head	54/-
177	Ditto " " with handsome chased seal head	54/-
178	Ditto " " with handsome chased seal head	54/-
179	Ditto " " with handsome chased seal head	54/-
180	Ditto " " with handsome chased seal head	54/-
181	Ditto " " with handsome chased seal head	54/-
182	Ditto " " with handsome chased seal head	54/-
183	Ditto " " with handsome chased seal head	54/-
184	Ditto " " with handsome chased seal head	54/-
185	Ditto " " with handsome chased seal head	54/-
186	Ditto " " with handsome chased seal head	54/-
187	Ditto " " with handsome chased seal head	54/-
188	Ditto " " with handsome chased seal head	54/-
189	Ditto " " with handsome chased seal head	54/-
190	Ditto " " with handsome chased seal head	54/-
191	Ditto " " with handsome chased seal head	54/-
192	Ditto " " with handsome chased seal head	54/-
193	Ditto " " with handsome chased seal head	54/-
194	Ditto " " with handsome chased seal head	54/-
195	Ditto " " with handsome chased seal head	54/-
196	Ditto " " with handsome chased seal head	54/-
197	Ditto " " with handsome chased seal head	54/-
198	Ditto " " with handsome chased seal head	54/-
199	Ditto " " with handsome chased seal head	54/-
200	Ditto " " with handsome chased seal head	54/-

Charlotte Street Steel Pen Works, Birmingham.

THE AMERICAN
COMPOUND SPIRAL PEN AND PENCIL CASE.



No. 253

The strongest and most serviceable Pencil Case ever introduced into the market. It is made with Pen at one end and Pencil at the other, both with Spiral Action.

No.	Description	Per Doz.
252	Aluminium Gold, plain	40/-
253	Ditto engine-turned or damasked	40/-
254	Sterling Silver	54/-

TOOTHPICKS.

No. 71

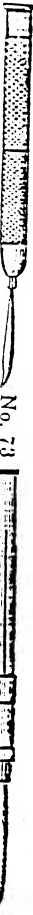

No. 73



No. 1234

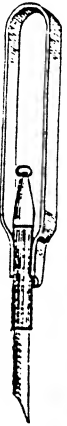

No.	Description	Per Doz.
89	Aluminium Gold, spiral and gold pick	16/-
201	Ditto spiral and tortoiseshell pick	10/8
76	Ivory in ivory case, with screw	14/-
714	Aluminium to slide and tortoiseshell pick	8/-
73	Nickel-plated, spiral and plated pick	4/-
718	Silver " spiral and plated pick	4/-
719	Gilt " " " " " "	4/-
1234	French Quill Toothpick, in nickel-spring holder	2/8
76	Tortoiseshell " " " " " "	4/-

BONE AND AGATE STYLES.

No. 4



No.	Description	Per Doz.
1	Bone Point, mounted in Ebony Holder	40/-
2	Agate " " " "	48/-
3	" " Bone " " "	48/-
4	" " and Penholder, in German-silver shut-up case	80/-
5	" " Penholder and Pencil " " "	90/-
6	" " in strong engine-turned silver-plated case, with seal	144/-
7	" " in nickel-plated case, to slide	48/-
8	" " " " " " " "	48/-

Charlotte Street Steel Pen Works, Birmingham.

POCKET PENCILS,

PROPELLING AND WITHDRAWING.

No. 798

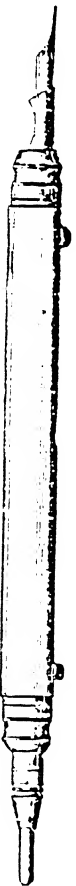

No. 617

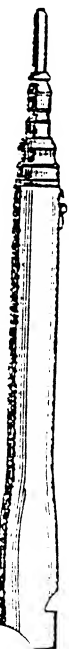

No. 619



No. 636



No. 630



No. 187B



IVORY PENNOL CASES.

No.	Description	Per Doz.
697	4-in. Handsomely-ornamented Pen, Pencil and Knife, two Blades	48/-
687	" " " " " " " "	40/-
609	" " " " " " " "	32/8
1B	3 1/2-in. " " " " " " " "	31/3
613	Bentol " " " " " " " "	31/9
231	Fetrol " " " " " " " "	29/1
230	Plain " " " " " " " "	27/5
698	Plain " " " " " " " "	32/6
603	Ornamented, Pencil and one Penknife Blade	16/-
254	" " and one " " " "	12/-
756	Plain " " " " " " " "	17/4
758	Pen and Pencil " " " " " " " "	8/3
759	Ditto Sliding Pencil " " " " " " " "	6/4

Charlotte Street Steel Pen Works, Birmingham.

BONE PENCILS.

12	Pen, Pencil and Knife	10/-
13	Ditto " superior quality	12/-
14	Sliding Pencil and Knife	6/8
15	Ditto " fixed point	4/4
16	Pen and Pencil, to slide on both ends	8/-
17	Ditto " " "	4/6
18	Ditto " " at same end	7/1
19	Ditto " " with lead reserve	7/1
20	Ditto " " with ball top	7/4
21	Ditto " reversible	3/4
22	Pen, Pencil and Knife, reversible	6/8
23	Pen and Pencil, reversible, with screw, lead reserve to each	4/-
24	Sliding-point Pencil, black or white, with ring	4/-
25	Ditto " large	4/-
26	Ditto " smaller, with lead reserve	3/4
27	Ditto " with ball top	3/4
28	Ditto " plain	3/4
29	Ditto " with whistle	6/8
30	Ditto " with microscope	8/-
31	3 1/2-in. Fixed-point Pencil	2/-
32	3-in. " " with ring	2/-
33	3-in. " " with ring	2/8
34	1 1/2-in. " " Pocket-book Pencil, with nickelized ball top	3/8

COCOA PENCILS.

60	Pen, Pencil and Knife	10/8
61	Sliding Pencil and Knife	6/8
62	Pen and Pencil, to slide at both ends	8/-
63	Ditto " " at same end, with lead reserve	7/4
64	Pencil only, to slide	4/-

TARTAN WOOD PENCILS.

19	Pen, Pencil and Knife	12/-
20	Sliding Pencil and Knife	6/8
21	" Pencil and Pencilholder	7/1
22	Sliding Pencil, with ring, small	4/-
23	Spiral Tablet Pencil, with ivory top	4/-
24	" " " "	2/-

Charlotte Street Steel Pen Works, Birmingham.

METAL PENCILS.

No. 786
No. 626
No. 804
No. 673
No. 671
No. 746
No. 650
No. 602

PURE NICKELISED AND METAL COMBINATION POCKET PENCILS

No.	Description	Per Doz.
787	Chassapod Movement, with reserve, ball top, half plain, half engraved, hexagon	8/-
647	Ditto " " seal top, gilt	8/-
626	Ditto " " silver-plated	8/-
702	Ditto " " ball top, danusk, nickel and gilt	8/-
715	Ditto " " engraved	8/-
788	Ditto " " home body	8/-
779	Spiral " " " " " "	8/-
719	Sliding " " " " " "	8/-
724	Spiral " " " " " " with band, hexagon	8/-
660	Ditto " " " " " " telescopic, engraved	8/-
	" " " " " " silver-plated	8/-

Charlotte Street Steel Pen Works, Birmingham.

METAL PENCILS—Continued.

		Pr. Dcs.
3	Spiral Movement, telescopic, plain	8/-
4	Ditto " " engraved, with ring	8/-
5	Ditto " " key	8/-
6	Ditto " " watch chain bar	8/-
7	Ditto " " plain, with reserve	8/-
8	Ditto " " engraved	8/-
9	Ditto " " engine-turned " "	8/-
10	Ditto " " damask, gilt, and nickel, with reserve	8/-
11	Ditto " " black enamelled	8/-
12	Ditto " " with ring	8/-
13	Ditto " " aluminium, with swivel	8/-
14	(Hingespot) " " plain	8/-
15	Ditto " " black damask, with ball end, reserve	8/-
16	Spiral " " " " with reserve	12/-
17	Algeria Extension, engine-turned	12/-
18	Ditto " " plain, with ring, small	16/-
19	Ditto " " black enamelled, with ring, small	16/-
20	Spiral Movement, plain, with ring	16/-
21	Ditto " " engraved, with reserve	6/-
22	Ditto " " plain,	4/-
23	Ditto " " fixed point, with ring	4/-
24	Ditto " " black enamelled, fixed point, with ring	2/8
25	Ditto " " fluted pocket-book pencil, with reserve	4/-
26	Ditto " " fixed point, with microscope	4/-
27	Slinging " " with band, hexagon, engraved, small, with ring	4/-
28	(Hingespot) " " plain, with reserve	4/-
29	Spiral " " " " with craser	4/-
30	" " " " elongating, German-silver, engraved	4/-
31	" " " " " " with ring	8/-

SUPERIOR METAL PEN AND PENCILS.

1	Pen and Pencil, to slide, both ends, nickel-plated damask	8/-
2	Ditto " " silver-plated	4/6
3	Ditto " " " " engine-turned	4/-
4	Ditto " " " " at same end, damask	8/-
5	Ditto " " spiral, with sliding penholder, silver-plated	8/-
6	Ditto " " reversible, damask, with seal top	4/-
7	Ditto " " German silver, damask, telescopic	4/4
8	Ditto " " " " plain, telescopic	4/-
9	Ditto " " " " engraved	4/-
10	Ditto " " nickel-plated	4/-
11	The Posting Pencil, long taper penholder and pencil, nickel-plated	4/-
12	The Stock Exchange Pencil, strong nickel-plated case, with ring and best cedar pencil	4/-
13	Pen and Pencil, reversible, nickel-plated	2/8
14	Ditto " " " " plain, with rubber	2/4
15	Ditto " " " " " " with cedar pencil and India-rubber	1/4
16	Ditto " " Case, reversible, with cedar pencil and India-rubber	3/2-

Charlotte Street Steel Pen Works, Birmingham.

ASSORTED POCKET PENCILS, on Illuminated Show Cards.

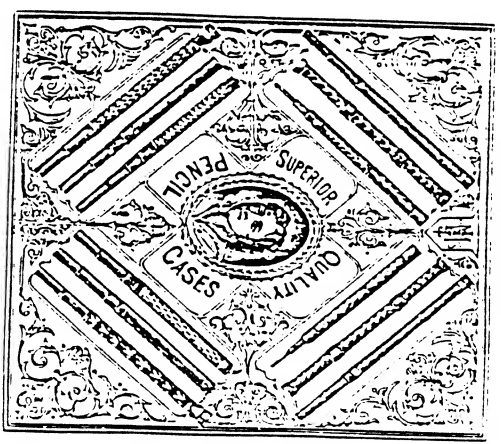

No.	Description	Pr. Dcs.
409	One dozen well assorted nickel, black, damask, and gilt Pencils	9/6
301	Ditto " " Bone Pencils	4/8
401	Ditto " " " " Yarnan Wood Pencils	9/6
501	Ditto " " " " German Silver Pencils	4/8
303	Ditto " " " " " " " "	4/8

ASSORTED POCKET PENCILS, in Counter Cases.

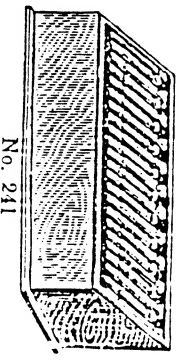
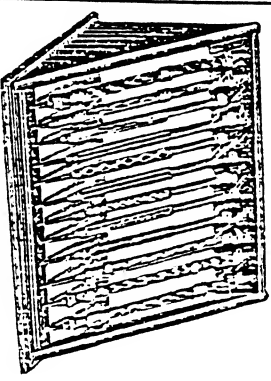

No.	Description	Pr. Dcs.
223	Superior Black-polished wood Case, with looking glass back, containing 1-doz. best finished nickel-plated Pencil Cases, assorted patterns	8/-
241	Superior polished wood Case, containing 2-doz Metal Pencil Cases, Splendid value	8/8
245	Ditto " " " " containing 2-doz. Bone Pencil Cases, assorted patterns	8/8
232	Ditto " " " " containing 1-doz. Aluminium Gold Pencils, assorted patterns	1/4

Charlotte Street Steel Pen Works, Birmingham.

ERASERS AND DESK KNIVES.

ERASERS.



No.	Description	Per Doz.
31	3 1/2-inch Flat Ebony Handle	4/8
32	3 1/2-inch " Cocoon	4/6
33	4-inch " Bone	5/1
34	4-inch " " "	7/1
35	4-inch " Coroon	6/-
36	4-inch " Ebony	6/-
37	4 1/2-inch " Ivory	6/8
38	4 1/2-inch " Ebony	9/4
39	4 1/2-inch " Bone	9/-
40	5-inch " Scotch Wood Handle	9/11
41	5-inch " Bone	10/-
42	5-inch " Scotch Wood	9/-
43	Small Patent Erasers	10/-
44		9/-

DESK KNIVES, with Straight Blades.



No.	Description	Per Doz.
71	4-inch Flat Cocoon Handle	5/-
72	4-inch Round Scotch Wood Handle	8/8
73	4-inch " and Curved Buffalo Handle	7/9
74	4 1/2-inch Tapered Bone	10/-
75	4 1/2-inch " Scotch Wood	10/-
76	4 1/2-inch " Cocoon	8/-
77	5-inch Flat Scotch Wood	10/-

DESK KNIVES, with Spear-Headed Blades.



No.	Description	Per Doz.
77	3 1/2-inch Flat Bone Handle	5/9
78	3 1/2-inch " " "	6/8
79	4 1/2-inch " Ivory	8/-
80	4 1/2-inch " " "	10/-

Charlotte Street Steel Pen Works, Birmingham.

DESK KNIVES—Continued.

No.	Description	Per Doz.
128	4 1/2-inch Flat Ebony Handle	7/7
56	4 1/2-inch " Scotch Wood Handle	10/6
68	5-inch " Cocoon	8/8
66	4 1/2-inch Flat Cocoon Wood Handle	7/7
69	4 1/2-inch " Bone	9/9
113	4-in. Square Ebony Handle, German-silver mount	11/11
127	4-in. " " " " " " " "	11/11
72	4-in. Round and Curved " " " " " " " "	8/8
77	4 1/2-inch Tapered Ebony Handle	8/8
85	4 1/2-inch " Cocoon	11/11
73	4 1/2-inch " Bone	8/8
55	4 1/2-inch " Scotch Wood Handle	11/11

All Erasers and Desk Knives on Cards of 1-Dozen.

M. MYERS & SON'S POCKET KNIVES,

BEST SHEFFIELD MAKE.

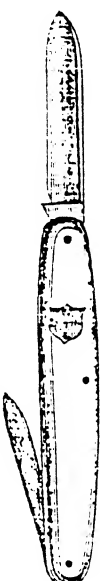

(For Description, &c., see Page 25.)

Charlotte Street Steel Pen Works, Birmingham.

P. BEST KNIVES, Best Sheffield Make.
 (FOR ILLUSTRATIONS, SEE PAGE 24)

ON CARDS OF DOZEN.

No.	Description	Per Doz.
721	Ivory, one blade	5/1
722	Buffalo, "	5/8
703	Carved Horn, two blades	9/8
705	Buck Horn, two "	9/8
708	Ditto "	9/8
717	Ivory, small, two "	9/8
713	Ditto, large, two "	9/8
714	Buffalo, two "	10/-
716	Ivory, two "	10/-
725	Pearl, small, German-silver mounted, two blades	10/-
726	Ivory, German-silver mounted, with shield, two blades	11/4
727	Ditto, long, plain, two blades	11/8
723	Ditto, small G.S. mounted, with shield, two blades	11/8
728	Ditto, with shield, two blades	12/-
707	Buffalo, G.S. mounted, two blades	12/-
711	Ivory, "	12/8
706	Buck Horn, with shield "	14/8
715	Ivory "	15/-
710	Pearl, small, G.S. mounted, with shield, two blades	15/-
720	Tortoiseshell, small, "	15/-
719	Pearl, small "	15/-
729	Ditto "	16/-
730	Ditto " plain, two blades	16/-
700	Buffalo, large, G.S. mounted, two blades	16/8
731	Ivory " with shield, two blades	16/8
704	Buck Horn, extra long, with shield, two blades	16/8
735	Ivory "	16/8
733	Ditto, G.S. mounted, with shield, three "	16/8
702	Ditto, with shield, extra long, three "	18/8
734	Buck Horn, with shield, extra long, two "	18/8
736	Ivory with shield, four blades	20/-
709	Buck Horn, G.S. mounted, with shield, three blades	20/-
711	Ivory "	21/8
742	Pearl "	21/8
747	Ivory " two blades	22/4
747	Ditto, small "	22/4
710	Ivory, with shield "	22/4
712	Ditto "	24/8
713	Ditto "	24/8
714	Tortoiseshell, G.S. mounted, with shield, three blades	25/4
714	Pearl, large "	30/8
708	Ditto, round, large, "	32/-
715	Buck Horn, G.S. mounted, with shield, three blades and cork screw	32/-
716	Ditto "	37/1
717	Ditto long, with shield, three blades	72/-
621	Scotch Tartan Wood, small, one blade	4/-
1	Ditto "	4/-
020	Ditto " one "	7/4
15	Ditto " one "	8/-
14	Ditto fruit knife, one blade	7/8
5	Ditto " larger, one blade	9/4
6B	Ditto two blades	12/-
8B	Ditto " two blades	12/8
25	Ditto large, two blades	12/8
32	Ditto " two "	12/8
013	Ditto small, three "	16/-
33	Ditto large, three "	16/8
	Ditto small, four "	18/8

Charlotte Street Steel Pen Works, Birmingham.

M. MYERS & SON, PATENTERS AND MANUFACTURERS
POCKET MICROSCOPES

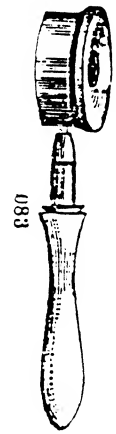

083

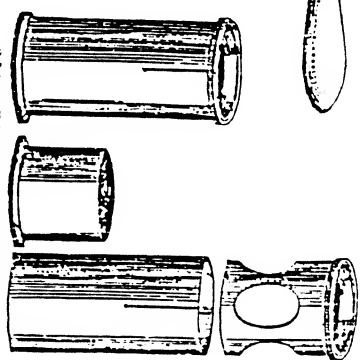

084.—The Elton Microscope.

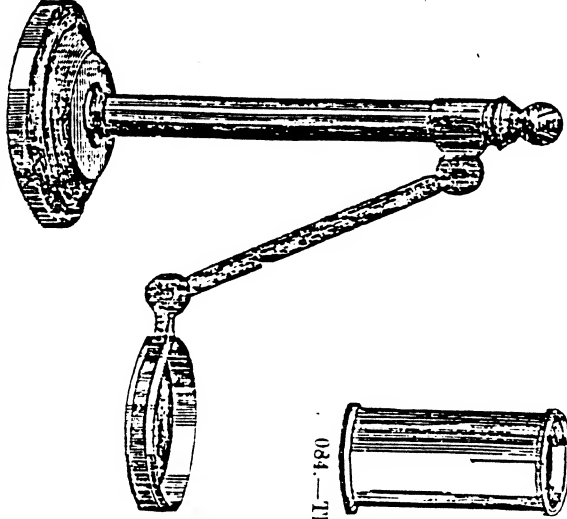

087.—For examining Flowers, Photographs, &c.

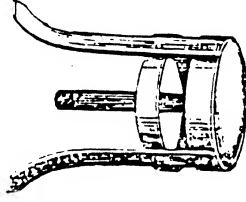

091

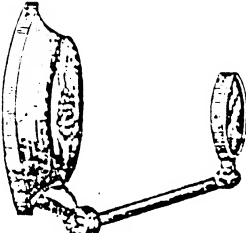

060

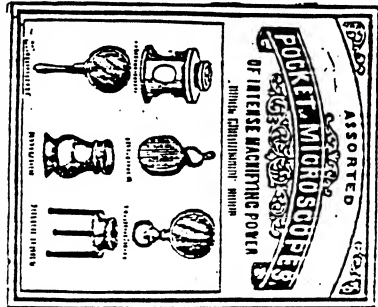

216.—Assorted Card

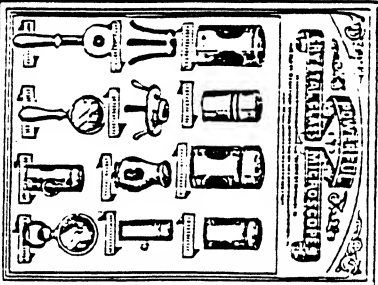

207.—Assorted Card

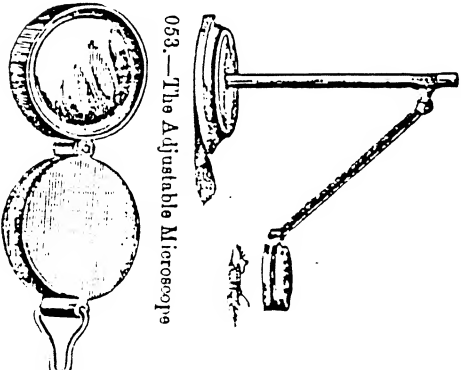

053.—The Adjustable Microscope

073

MICROSCOPES—Continued.

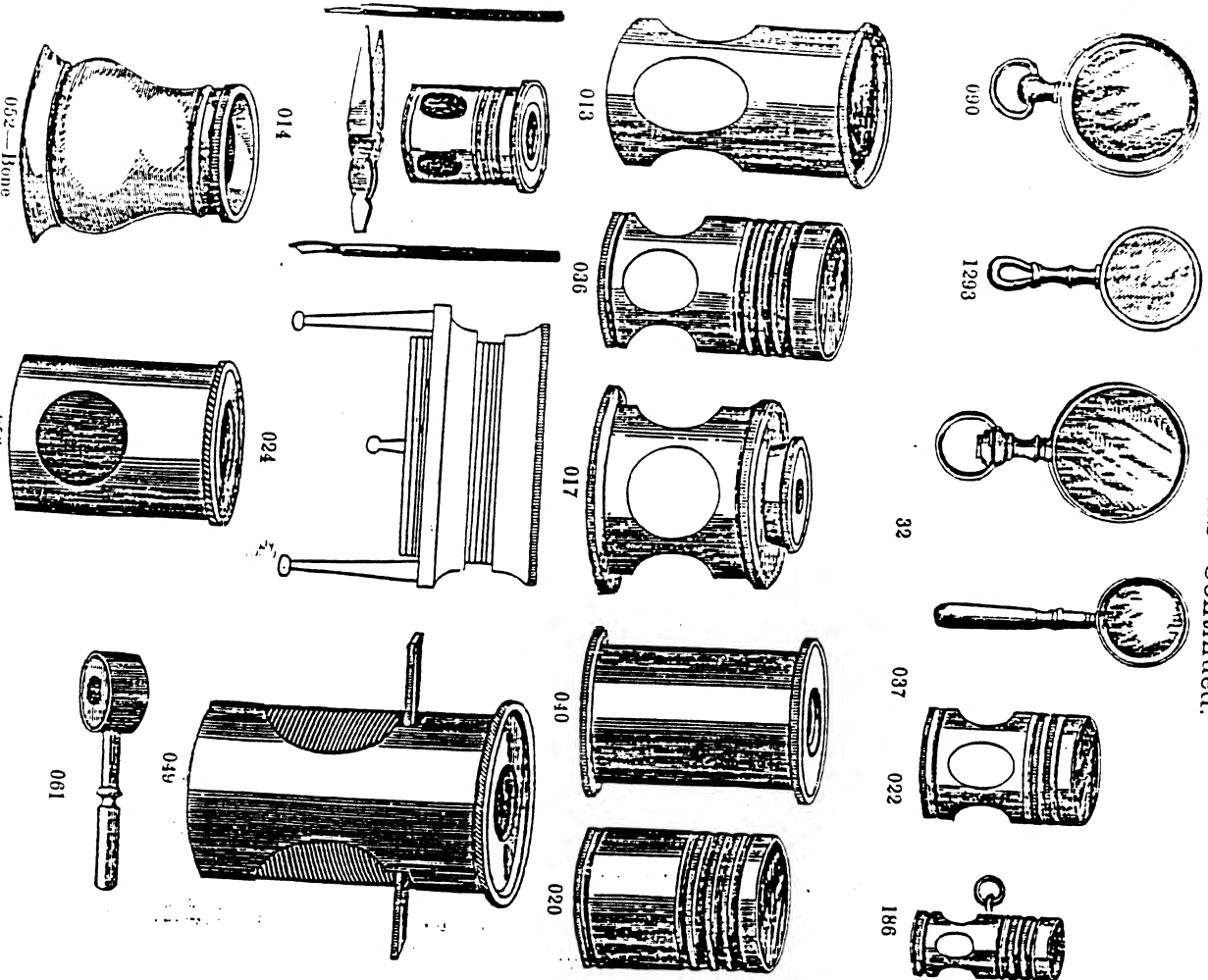

MICROSCOPES—Continued.

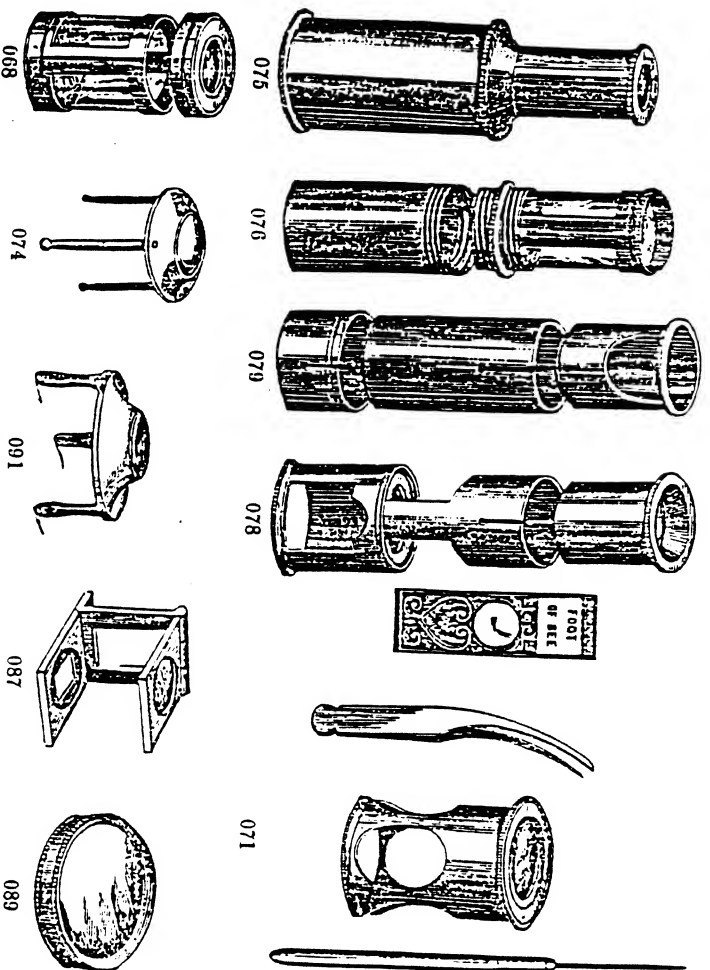

POCKET MICROSCOPES.

HIGH MAGNIFYING POWER.

Carded or Boxed in Dozens. For Illustrations, see Pages 26, 27 & 28.

No.	Description	Per Doz.
186	Small Darrel Microscope, with ring	48/-
082	Ditto " " hook canopy, with ring	48/-
32	Pocket Microscope, with ring, nickel-plated, very powerful lens	96/-
35	The "Jarrington" Microscope	48/-
013	Pocket Microscope, long tube	96/-
014	Ditto " " with dissecting instruments	96/-
071	Ditto " " nickel-plated, with dissecting instruments	96/-
024	Botanic Tripod, 1 1/2-in. with screw movement	16/-
016	Ditto " " 1 1/2-in.	26/8
086	Ditto " " 1 1/2-in.	36/-

Charlotte Street Steel Pen Works, Birmingham.

MICROSCOPES—Continued.

Carded or Boxed in Dozens. For Illustrations, see Pages 26, 27 & 28

17	Huskyan Microscope	..	96/-
18	Pocket Microscope, double lens, very powerful	..	144/-
19	Ditto	..	48/-
20	Ditto	..	48/-
21	Ditto	..	48/-
22	Ditto	..	48/-
23	Ditto	..	48/-
24	Ditto	..	48/-
25	Ditto	..	48/-
26	Ditto	..	48/-
27	Ditto	..	48/-
28	Ditto	..	48/-
29	Ditto	..	48/-
30	Ditto	..	48/-
31	Ditto	..	48/-
32	Ditto	..	48/-
33	Ditto	..	48/-
34	Ditto	..	48/-
35	Ditto	..	48/-
36	Ditto	..	48/-
37	Ditto	..	48/-
38	Ditto	..	48/-
39	Ditto	..	48/-
40	Ditto	..	48/-
41	Ditto	..	48/-
42	Ditto	..	48/-
43	Ditto	..	48/-
44	Ditto	..	48/-
45	Ditto	..	48/-
46	Ditto	..	48/-
47	Ditto	..	48/-
48	Ditto	..	48/-
49	Ditto	..	48/-
50	Ditto	..	48/-
51	Ditto	..	48/-
52	Ditto	..	48/-
53	Ditto	..	48/-
54	Ditto	..	48/-
55	Ditto	..	48/-
56	Ditto	..	48/-
57	Ditto	..	48/-
58	Ditto	..	48/-
59	Ditto	..	48/-
60	Ditto	..	48/-
61	Ditto	..	48/-
62	Ditto	..	48/-
63	Ditto	..	48/-
64	Ditto	..	48/-
65	Ditto	..	48/-
66	Ditto	..	48/-
67	Ditto	..	48/-
68	Ditto	..	48/-
69	Ditto	..	48/-
70	Ditto	..	48/-
71	Ditto	..	48/-
72	Ditto	..	48/-
73	Ditto	..	48/-
74	Ditto	..	48/-
75	Ditto	..	48/-
76	Ditto	..	48/-
77	Ditto	..	48/-
78	Ditto	..	48/-
79	Ditto	..	48/-
80	Ditto	..	48/-
81	Ditto	..	48/-
82	Ditto	..	48/-
83	Ditto	..	48/-
84	Ditto	..	48/-
85	Ditto	..	48/-
86	Ditto	..	48/-
87	Ditto	..	48/-
88	Ditto	..	48/-
89	Ditto	..	48/-
90	Ditto	..	48/-
91	Ditto	..	48/-
92	Ditto	..	48/-
93	Ditto	..	48/-
94	Ditto	..	48/-
95	Ditto	..	48/-
96	Ditto	..	48/-
97	Ditto	..	48/-
98	Ditto	..	48/-
99	Ditto	..	48/-
100	Ditto	..	48/-

Charlotte Street Steel Pen Works, Birmingham.

EXCELLENTIOR READING GLASSES

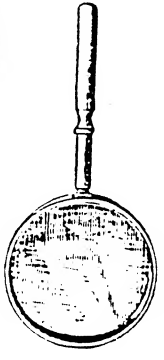

No.	Diop. Power	1 1/2	2	2 1/2	3	3 1/2	4	4 1/2	5	5 1/2	6
3	Bronze Frames, Bone Handles, per doz.	4/-	8/-	12/-	16/-	21/-	28/-	36/-	45/-	54/-	63/-
4	Nickel	4/-	8/-	12/-	16/-	21/-	28/-	36/-	45/-	54/-	63/-
5	" " Black	4/-	8/-	12/-	16/-	21/-	28/-	36/-	45/-	54/-	63/-
6	Nickel	4/-	8/-	12/-	16/-	21/-	28/-	36/-	45/-	54/-	63/-

READING GLASSES, Assorted, on Cards.

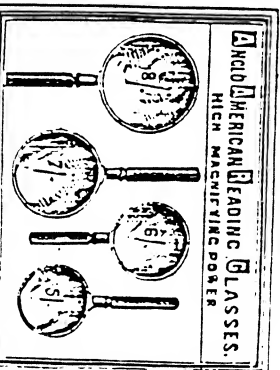
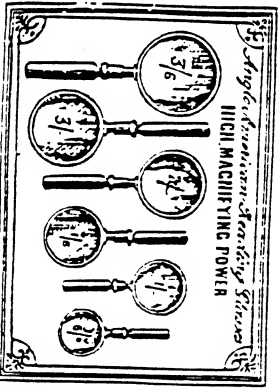

No.	Diop. Power	1 1/2	2	2 1/2	3	3 1/2	4	4 1/2	5	5 1/2	6
205	Containing one each	1 1/2	2	2 1/2	3	3 1/2	4	4 1/2	5	5 1/2	6
206	Ditto	1 1/2	2	2 1/2	3	3 1/2	4	4 1/2	5	5 1/2	6
215	Ditto	1 1/2	2	2 1/2	3	3 1/2	4	4 1/2	5	5 1/2	6

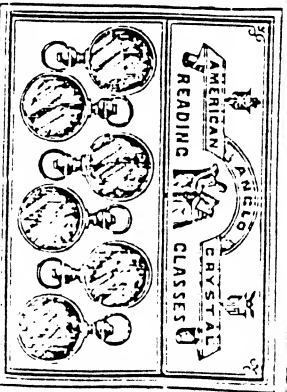

1358	Pocket Reading Glass, nickel-plated frame, with ring	96/-
072	Ditto	18/-

Charlotte Street Steel Pen Works, Birmingham.

READING GLASSES—Continued.
 RACK OF TWELVE READING GLASSES

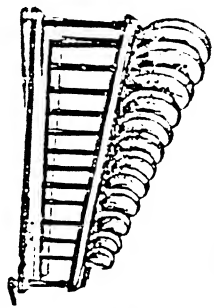

Handsome Mahogany Rack.
 Containing 12 Reading Glasses, viz.:—two each 1½, 2-in., one each 2½, 2¾, 3, 3½, 3¾, 4-in. Diameter.

No. 3.	No. 4.	No. 5.	No. 6.
Brass Frames, Bone Handles. 31/9	Nickel Frames, Bone Handles. 31/9	Brass Frames, Black Handles. 30/6	Nickel Frames, Black Handles. 30/6

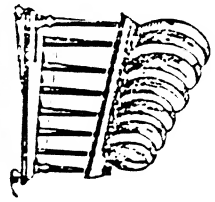

Handsome Mahogany Rack.
 Containing 6 Reading Glasses, viz.:—one each 2½, 3, 3½, 3¾, 4-in. Diameter.

No. 3A.	No. 4A.	No. 5A.	No. 6A.
Brass Frames, Bone Handles. 26/6	Nickel Frames, Bone Handles. 26/6	Brass Frames, Black Handles. 24/-	Nickel Frames, Black Handles. 24/-

THE NEW REGISTERED READING GLASSES

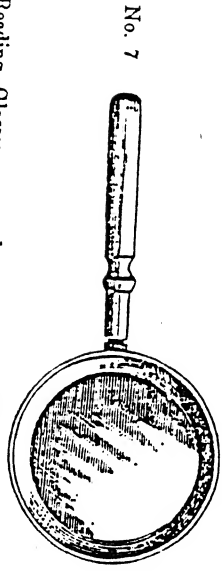
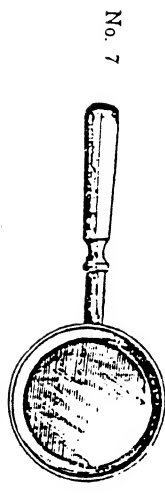

These Reading Glasses are made upon an entirely new and improved principle, the metal rim which holds the lens, being made of solid tube, there is no danger of any part coming un-soldered; they are also much stronger, and have a better appearance than the old kind.

7	Brass Frames, Bone Handles, per doz.	1½	2	2½	2¾	3	3½	3¾	4 in.
8	Nickel " "	4/-	8/-	12/-	16/-	28/-	28/-	31/-	
9	Brass " "	4/-	8/-	12/-	16/-	24/-	28/-	31/-	
10	Nickel " "	4/-	8/-	12/-	16/-	24/-	28/-	31/-	

Not made larger. With Bone Handles, 53/4 64/- 53/4 64/-

M. MYERS & SON'S
 PATENT ELASTIC BANDS

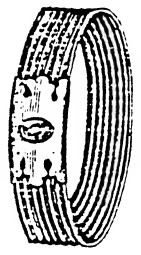

For Purses, Pocket Books, Letters, &c., &c., these Bands, which are to be had in all sizes, will prove of great use. The Elastic is fastened by a Spring Slip, which can be unfastened and a new elastic inserted.

No.	4-in.	5-in.	6-in.	7-in.	8-in.	9-in.	10-in.	11-in.	12-in.
15	8/-	9/4	14/6	15/3	16/-	24/-	30/-	30/-	24/-
	4-in.	5-in.	6-in.	7-in.	8-in.	9-in.	10-in.	11-in.	12-in.
	Medium, Thread, Silk,								

PATENT STAMP DAMPER.

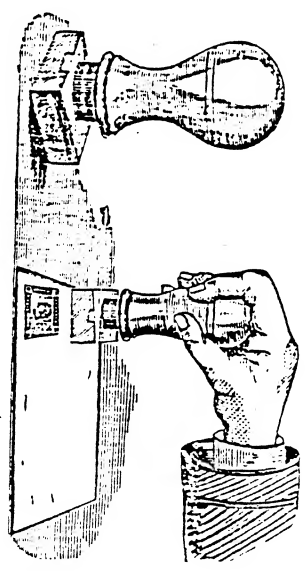

A very useful article for Damping Postage Stamps, Envelopes, and other adhesive papers.

Carded, 1-dozen on Card, with directions for use 8/-

Charlotte Street Steel Pen Works, Birmingham.

M. MYERS & SON'S

PATENT LETTER CLIPPS.

1879 Jockey
1879 Crown
1863 Ship
1872
1878
1877
1861
1874
1863
1872
1869
1880

Illustrated Full Size

No.	Description	Price
1861	Patent Flat Steel Springs ..	32/-
1863	"	32/-
1869	"	32/-
1870	"	32/-
1871	"	32/-
1872	"	32/-
1873	"	32/-
1874	"	32/-
1875	"	32/-
1876	"	32/-
1877	"	32/-
1878	"	32/-
1879	"	32/-
1880	"	32/-
1881	"	32/-
1875	Nickel, Patent [?]	32/-
1876	"	32/-
1877	"	32/-
1878	"	32/-
1879	"	32/-
1880	"	32/-
1881	"	32/-
1875	"	32/-
1876	"	32/-
1877	"	32/-
1878	"	32/-
1879	"	32/-
1880	"	32/-
1881	"	32/-
1875	"	32/-
1876	"	32/-
1877	"	32/-
1878	"	32/-
1879	"	32/-
1880	"	32/-
1881	"	32/-

Charlotte Street Steel Pen Works, Birmingham

M. MYERS & SON'S

PATENT TICKET FASTENERS AND VALENTINE HOOKS

For suspending Cards in Shop Windows, and for various other purposes.

11 DRAPERS FRIEND.
13 STATIONERS FRIEND.
18 STATIONERS FRIEND.

No.	Description	Price
18	Stationers' Friend, steel	1/-
18	"	1/-
11	Drapers' Friend, steel	2/-
11	"	1/-
11	"	1/-
13	Flat Suspenders, steel, for cards, porcelain plates, &c.	2/4
2	"	3/4
20	Small Steel Clip, for holding papers	3/4

ALMANACK SUSPENDERS

BRASS OR SILVERED.

No. 21

8/-

9/8

2/2

10/8

21

Charlotte Street Steel Pen Works, Birmingham.

M. MYERS & SON'S

JEWELLERS' PATENT TICKET HOOKS.

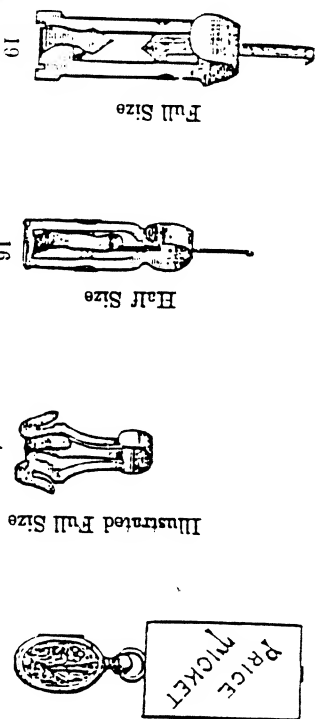

No.	Chain and Locket Hook, steel	Per Gro.
1	Gilt	4/8
1	Watch and Locket Hook, steel, small	6/8
1	Gilt	8/-
161,	" " " steel, large	10/8
161,	Gilt	8/-
161,	" " " "	13/1

BRASS TABS FOR JEWELLERS.



No.	Oral	Per Gro.
1	Square	8d.
2	"	8d.

PASTE AND GUM BRUSHES

No.	Superior Quality Round Brush, on cards of 1 dozen	Per Gro.
1	Ditto	6/8
1A	Ditto in boxes of 1-gross	6/7
2	Ditto large size, on cards of 1 dozen	13/4
2A	Ditto in boxes of 1-gross	12/8

Charlotte Street Steel Pen Works, Birmingham.

PATENT BOOK MARKERS.



No.	Small Steel Bookmarker	Per Gro.
87	Ditto Gilt	8/-
86	Plat Indicators, gilt	12/-
32	Bookmarker and Paper Knife, flat, gilt	6/8
20	" " Ivory Blade, gilt mounts	8/-
20B	" " Tortoiseshell Blade, gilt mounts	37/1
20S	" " Ivory " black	37/1
21	" " Tortoiseshell Blade, gilt mounts	37/1
25	" " Ivory " "	48/-
28	" " Turtan Wood " large size	48/-
	" " " "	60/8

PATENT KEY CHAINS, WITH KEYS ATTACHED FOR OPENING THE SNAPS.

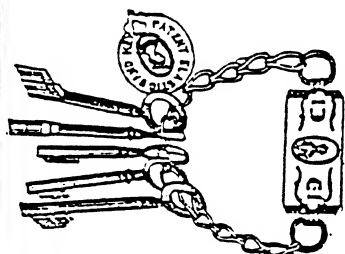

No.	Steel Chain, gilt snap	Per Gro.
1	"	16/-
2	"	24/-

PYRAMID SEAL.

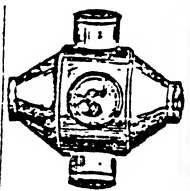

No. 1301—Nickel-plated Seal, with six different designs

Charlotte Street Steel Pen Works, Birmingham.

PATENT LEAD PENCIL POINT PROTECTOR



To those people who still prefer the Cedar Pencil these Point Protectors will be found of use, and also the artist, who will be enabled by their use to keep unbroken the finest point of his pencil. Easily removed.

No.	Description	Per Dozen	Per Gross
0	Richly Gilt, for small pencils, on cards of 3 dozen	..	8/-
1	Ditto " medium "	..	8/-
2	Ditto " large "	..	8/-
3	Brass " " "	..	9/4
4	Ditto, in boxes of 1 gross	..	2/6
	Silvered, with India Rubber, on cards of 3 dozen	..	4/-

LEAD PENCIL, POINT PROTECTOR & ERASER



222	Bronzed Point Protector, with rubber and superior cedar pencil, on cards of 3 dozen.	8/-
1332	Gilt " " "	16/-
1332 1/2	Nickelized " " "	16/-
1333	Ditto " " "	16/-
	with propelling and repelling eraser	24/-

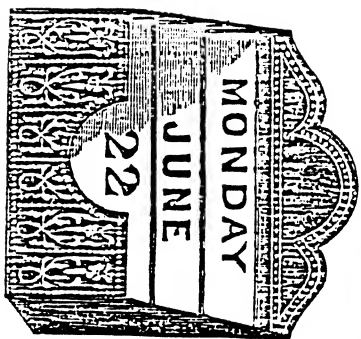

THE PERPETUAL DATE CASE

No. 1329—In English, French, or German, on Cards of 1 dozen .. 32/-

Charlotte Street Steel Pen Works, Birmingham.

SUPERIOR QUALITY PATENT PAPER BINDERS

(For Description, &c., see Page 39.)

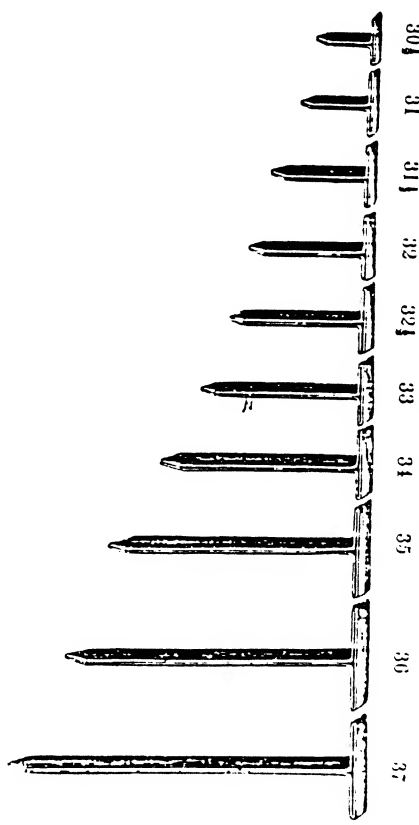

6		318w
5		
4		
3		
2		
1		
0		
00		
318		
318w		
21		
22		
01		
02		
03		
04		
05		
06		
07		
08		

Charlotte Street Steel Pen Works, Birmingham.

M. MYERS & SON'S

UPERIOR QUALITY PATENT PAPER BINDERS

(For Illustrations, see Page 38)

Heads, silver-plated	5/-	5/8	6/8	8/-	9/8	13/-	17/8	25/-	30/-	36/-	per great gross
	30/1	31	31 1/2	32	32 1/2	33	34	35	36	37	(12 gross)
Heads, silver-plated	7/1	9/-	9/8								
	21	22	318W.								
Ditto brass	9/-										
	318										
Heads, brass	5/-	5/8	6/-	4/8	10/8	12/6	14/8	19/8			
	00	0	1	2	3	4	5	6			
Ditto brass, light series	5/1	5/8	6/8	8/-	9/1	10/8	12/8	15/-			
	C.1	C.2	C.3	C.4	C.5	C.6	C.7	C.8			
Heads, nickel-plated	5/1	5/8	6/8	8/-	9/1	10/8	12/8	15/-			
	W.1	W.2	W.3	W.4	W.5	W.6	W.7	W.8			
Myers & Son's Patent	12/-	12/-									
	M.1	M.2									

BEST CUMBERLAND LEADS,
IN METAL BOXES, suitable for all Propelling and Repelling Pencils.



Round, coloured tin boxes, containing three 2-in. leads	6/8										Per Doz.
Flat, brass boxes, small size	6/8										6/8
Ditto " large	6/8										6/8
Ditto, fancy brass boxes, large size	8/-										8/-
	24/-										24/-

METALLIC RULERS

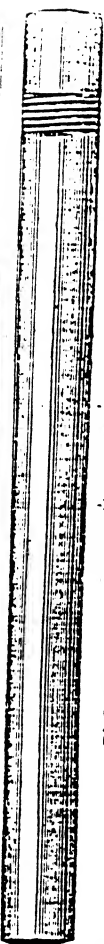

No. 4	7-in. Polished Brass Ruler, lacquered	48/-	Per Doz.
6	9-in. Nickel-plated Ruler, with Penholder, Pencil and Eraser	96/-	Per Doz.
10	9-in. Black Enamelled Ruler, with Penholder, Pencil and Eraser	96/-	Per Doz.

On Cards of 1-dozen.
Charlotte Street Steel Pen Works, Birmingham.

THE HOUSEHOLD PAPER PIERCER

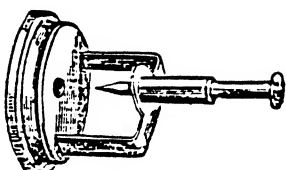

The Illustration represents a contrivance for piercing holes in a number of Invoices, or pieces of paper to facilitate the insertion of paper fastener or string.

The article is made of bronzed metal, and will be found very useful for domestic as well as office use.

Carried in 1/2 dozens. 8/- per dozen.

1338

THE SPECIAL PEN BOXES



248

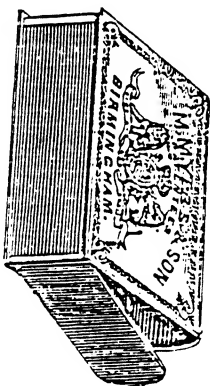

1878

No. 248	Handsome Marbled Box, assorted colours, with hinged lid, containing 1/2-gross best quality steel pens. One dozen boxes on card	96/-	Per Doz.
1878A	Handsome Metal Book Box, containing four dozen good steel pens, assorted	96/-	Per Doz.
1878	Ditto " with one gross pens, No. 3086	13/1	Per Doz.

WHIST MARKERS.

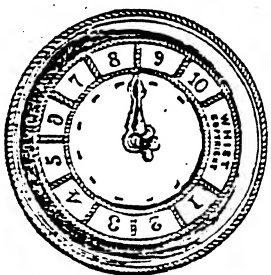

No. 1—Small Round Brass Whist Marker. One doz. on card.
No. 2—The Sentinel Whist Marker. One pair in box.

Charlotte Street Steel Pen Works, Birmingham.

POCKET LAMPS.

(ILLUSTRATED 1-SIZE)

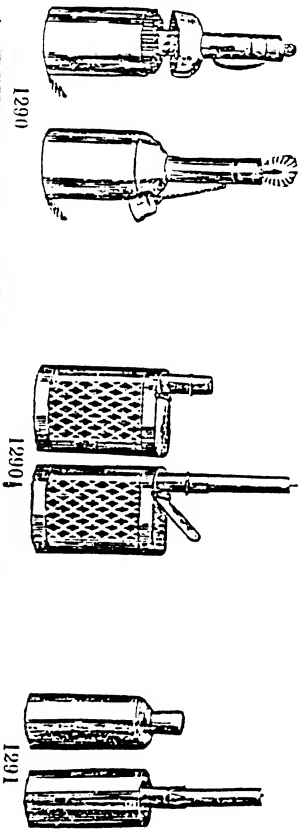

No.	Nickel-plated Pocket Lamp, spring action, with Match Box combined	Per Doz.
1290	Ditto Pocket Lamp and Match Box	96/-
1291	Ditto " small, round	96/-
	Boxes of Candles suitable for these Lamps	48/-
		Per Doz.

NEW POCKET LAMP

(ILLUSTRATED 1-SIZE)

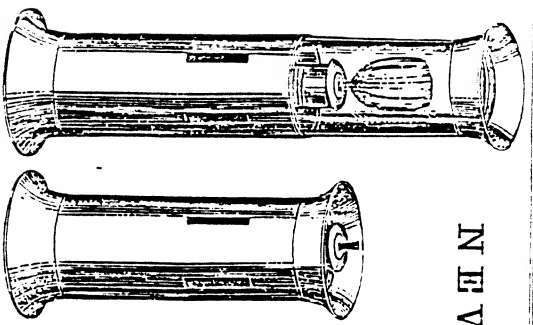

No. 250.—Brass Pocket Lamp, spring action, with telescopic glass shade, quite new, 96/- per gross.

THE EUREKA CANDLE LAMP.

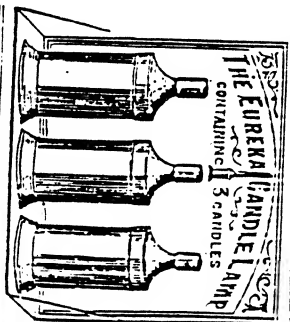

No. 1295.—Brass Box and Lamp, containing three Wax Candles. Useful for the Office Desk

INKSTANDS.

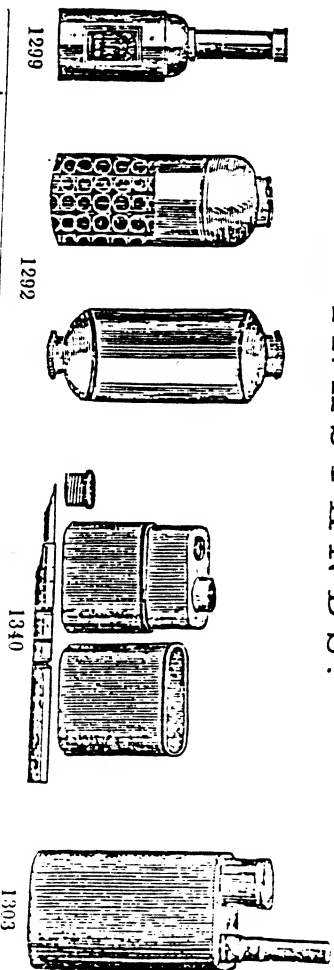

No.	Brass Pocket Inkstand, containing Ink Pellets, with which good Ink can be made by adding clear water	Per Doz.
1292	Brass Perpetual Ink Bottle, containing Solid Ink. A supply of good Ink can always be obtained from this bottle by adding clear water	96/-
1299	Nickel-plated Collector's Pocket Inkstand, flat, with Telescopic Penholder. Glass Ink bottle	96/-
1303	Ditto " " round	96/-
1303 1/2	The Commercial Pocket Inkstand, in Leather Case, with Telescopic Penholder	96/-
1340	Ditto " " with Telescopic Penholder	96/-

Very useful for Commercial Travellers, Collectors, &c

PENCILS, WITH MAGNIFIERS



No. 670.—A very handy little article, made in Metal, Bone and Aluminium.

No.	Fixed Point, Metal, Electro-plated	Per Doz.
721	Sliding Point, Bone	48/-
670	Spiral Point, Aluminium	96/-
640		114/-

Charitable Street, Steel Pen Works, Birmingham.

NICKEL-PLATED PAPER KNIVES.

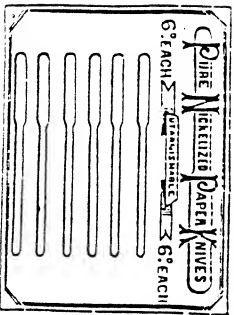

No. 1298.—Nickel-plated Paper Knife. On cards of 1 doz.

Per Doz. 48/-

PENHOLDERS, WITH INKSTANDS COMBINED

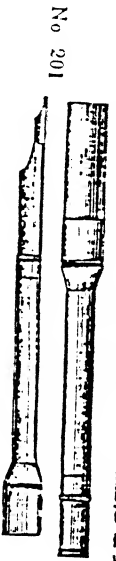

No. 201

Everybody's Companion, Nickel-plated Penholder and Inkstand. On cards of 1 dozen The Lilliputian Penholder and Inkstand, with Glass Ink Bottle

No. 688

Per Gro 48/-
48/-

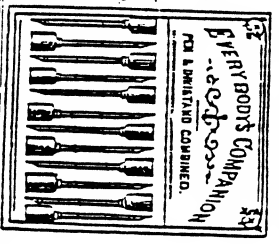

NEW PATENT MARVELLOUS PEARLS

(PATENTED IN FRANCE AND ABOARD)

THE WRITER WITHOUT INK WITH ALL KINDS OF PENS.



Take a pearl with the paper adhering to it. If the weather is dry soften the same by breathing upon it, or by holding it to a mild heat for a few seconds; then press it into the cavity of the pen. Remove the paper and steep the pen in water if you wish to write. One pearl is sufficient for one month. A large pen will hold two pearls. May be had to make RED, BLACK, or VIOLET INK.
Boxes containing Twenty Rolls of Pearls, 3/4 per Box.

MATCH AND FUSEE BOXES

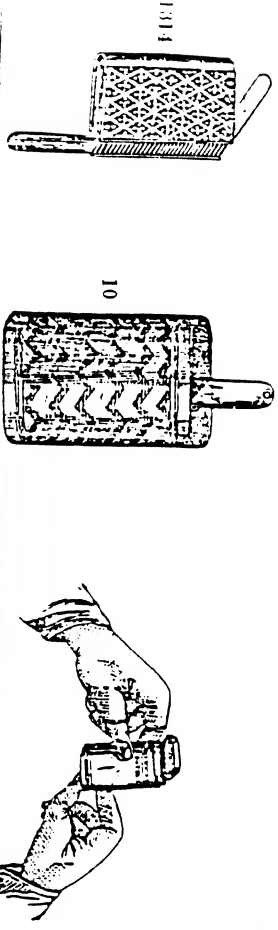

No	The Patent Magic Match Box, Silver-plated, superior finish	Per Doz
0	Nickel-plated, Patent Slide, Match Box	16/-
2	Ditto Hinged Lid	12/-
10	Gilt, Hook Shape, Match Box	4/4
1314	Nickel-plated	4/-
9	Leather centre	8/-

Charlotte Street Steel Pen Works, Birmingham

A NEW ROUND GAME

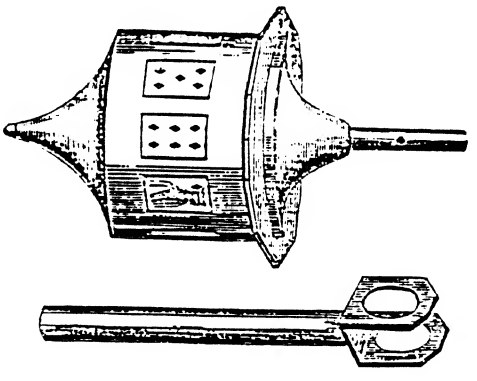

MONACO, OR PARLOUR LOTTERY

This novel and interesting Game is an endless source of amusement to old and young. It is, without doubt, the most perfect Round Game ever invented, and will we feel convinced, be a constant fund of enjoyment through the long Winter evenings; the excitement never flagging for a moment, and as any number of persons can conveniently play at the same time, the Monaco or Parlour Lottery cannot fail to be universally appreciated. We present a sheet of instructions for the Game with each Monaco.

Separately Boxed, 96/- per gross.

THE PSEUDOSCOPE.

The various changes of form and colour which may be soon with this article will be found very interesting to persons fond of studying the blending of colours.

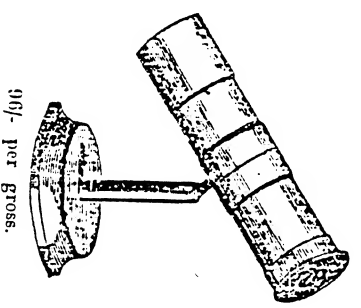

The Pseudoscope may either rest on the Table or can be held up to the eye, when by slightly twisting the tube round, the various formations may readily be seen.

96/- per gross.

Charlotte Street Steel Pen Works, Birmingham.

THE COMPANIONS

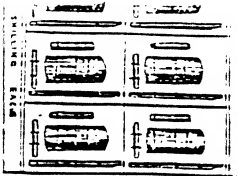

No. 8—Brass Pocket Companion, consisting of Bottle of Ink, Pencil, Penholder, Box of Pens, and Box of Leads. Six sets on a card 95/-

POCKET COMPANIONS.

THE SCHOOL BOARD PEN.

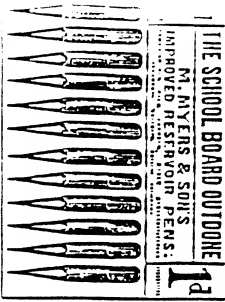

No. 3181—School Board Pen. The most perfect Reservoir Pen in the market. The very large sale this Pen commands is the best proof of its quality. On cards of 1 dozen 8/-

CIGAR CUTTERS AND BOXES

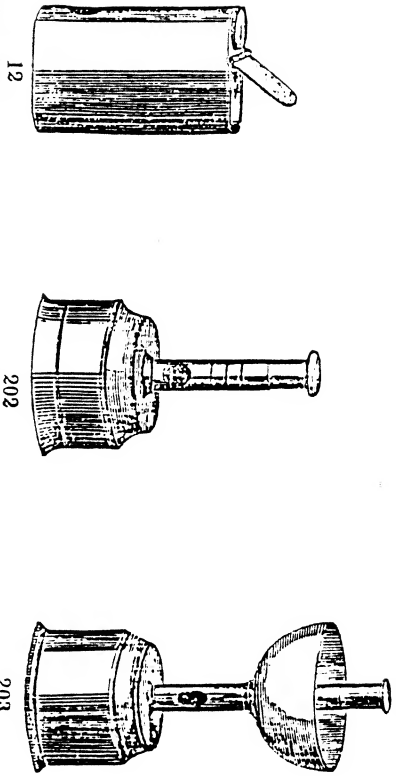

No. 12	Nickel-plated Cigar Cutter and Box	Per Doz. 12/-
"	" with Ash Tray	" 21/6
"	and Match Box for the Pocket	" 8/-

Charlotte Street Steel Pen Works, Birmingham.

PATENT TELESCOPIC CIGAR CUTTERS.

No. 1	Steel, black	Per Doz. 20/-
" 1	Ditto, gilt	" 32/-
" 2	G. Silver Nickelized	" 48/-

CIGAR CUTTER PENCILS



No. 750 | Nickel-plated Cigar Cutter, with Pen and Pencil combined Per Doz. 8/-

SMOKERS' COMPANION.

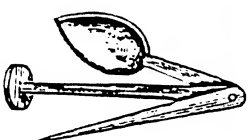

German-silver. On cards of 1 dozen 10/- per Gross

FLORAL SYRINGES.



No. 1297	Brass Syringe, 8 1/2 inches long, with Screw Lock and Rose	Per Doz. 8/-
" 1297A	Nickelized "	" 8/-
" 1297B	" " with extra fine holes	" 8/-

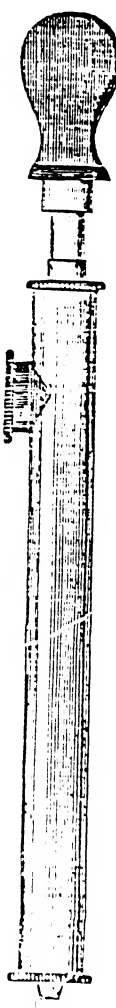

No. 1341 | Brass Syringe, 9 inches long, with Rose and Jet Per Doz. 20/-

Charlotte Street Steel Pen Works, Birmingham.

CARDED PENS.

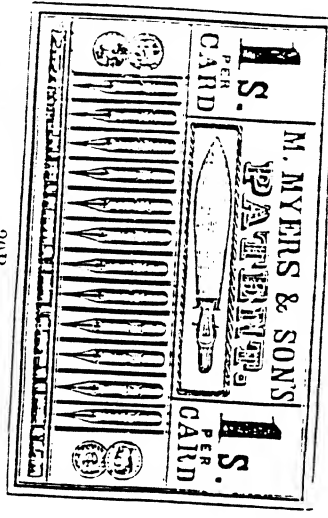

20P

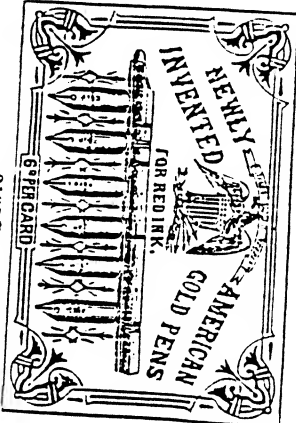

31990

No.	Description	Per Doz.
031G	One doz. Best Gilt Pens and Tartan Holder with gilt tip, on card	48/-
31990C	Half doz. American Gold Pens and German-silver Holder	48/-
	Millum-in-Larvo Card, containing twelve good Pens, Penholder, India Rubber, Gilt Indicator, Keypack, and Gilt Pen	48/-
20P	One doz. Best Gilt Pens and Tartan Holder, gilt tip, with Ivory Paper Knife	48/-
20SP	One doz. " " " " with Tortoiseshell	90/-
25P	One doz. " " " " Tartan	90/-

SCOTCH TARTAN

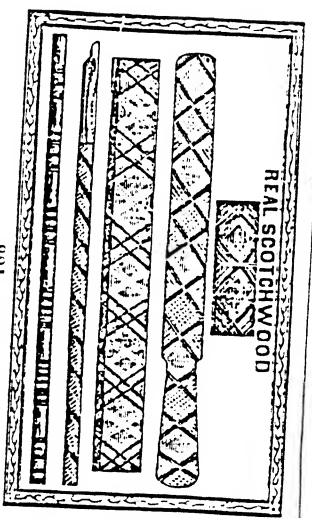

821

WRITING MATERIALS

No.	Description	Per Doz.
820	Card, containing Penholder, Pencil, Flat Ruler, and Paper Knife; Scotch Tartan	54/-
819	Card, containing Penholder, Pencil, Flat Ruler, Paper Knife & Pen Box; Scotch Tartan	68/-
822	Card, containing Penholder, Pencil, Flat Ruler, Paper Knife, Pen Box, and Penknife	116/-
823	Card, containing Penholder, Pencil, Flat Ruler, and Paper Knife; Coloured Flowers	57/-
825	Card, containing Penholder, Pencil, 9-inch Flat Ruler, 9-inch Paper Knife, Pen Box, Penknife, and Flat India Rubber; Scotch Tartan	72/-
903	Card, containing 9-inch Paper Knife, 9-inch Flat Ruler, Date Case, and Inkstand	21/4

Charlotte Street Steel Pen Works, Birmingham.

SCOTCH TARTAN GOODS

MANUFACTURED BY M. MYERS & SON.

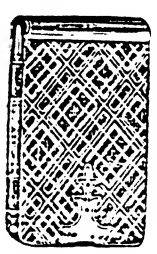

106

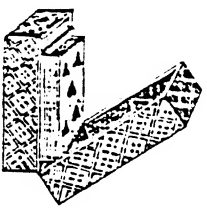

198

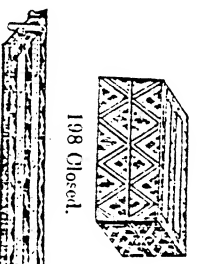

192

No.	Description	Per dozen	No.	Description	Per dozen
178	Ash Cup	10 8	281	Date Box, English	11 8
312	Ash Tub	8 0	425	Ditto French	11 8
802	Assorted Articles, 12 on a Card, 6d. each, por doz Cards	48 0	426	Ditto German	11 8
800	Ditto " " 12 " 6d. " "	72 0	361	Date and Stamp Box	21 0
800	Ditto " " 18 " 1/- " "	96 0	98	Emery	3 4
348	Band Box	7 6	427	Egg Box, small	3 4
199	Berzique Markers, small	7 4	428	Ditto 3 in.	8 0
197	Ditto " large	8 0	292	Egg Holder	6 0
396	Berzique Box	40 0	90	Egg Cup	7 4
25	Book Marker, patent spring clip	4 0	429	Eggs, assorted	4 0
28	Ditto " "	5 6	389	Eraser, flat	2 8
111	Bookin Case, large	3 4	15	Fruit Knife, small	7 4
96	Credchet " round	10 8	14	Ditto " large	8 0
208	Ditto " oval	13 0	88	Fuson Box, oval slide, medium	8 0
209	Ditto " hexagon	13 0	413	Ditto " large	8 0
125	Card Case, (tomb), pull off	15 0	265	Ditto " pull off	8 0
414	Ditto " hingead	16 4	293	Glove Stretcher, small	7 4
415	Ditto " "	16 4	287	Ditto " medium	11 0
215	Ditto " " " " " "	14 6	291	Ditto " large	13 0
296	Ditto " " " " " "	18 8	169	Hair Pin Box, round	7 4
406	Ditto " " " " " "	20 0	282	Ditto " with drawer	12 0
279	Ditto " " " " " "	18 6	205	Inkstand, small round	8 0
260	Card Box, 1 pack English Cards, borcolled edge " hingead, " "	20 0	99	India Rubber	22 0
270	Ditto " 2 " French " " "	18 8	166	Indepso Box, flat	4 0
417	Ditto " 2 " " " " " "	25 0	165	Ditto " deep	4 0
161	Ditto " 2 " " " " " "	33 4	232	Match Box, small round	4 0
183	Ditto " 1 " " " " " "	33 4	137	Ditto " medium	5 4
333	Ditto " 2 " " " " " "	36 0	206	Mirror, pocket	5 4
333	Count Planeter, small	8 0	173	Match Box, oval, small	7 4
214	Count Planeter, large	10 8	138	Ditto " medium	6 8
244	Ditto " " " " " "	14 0	172	Ditto " hingead	12 0
162	Gilbago Board, large	8 0	358	Ditto " barrel	6 3
303	Ditto " " " " " "	8 0	135	Ditto " bull, small	8 8
198	Ditto Box, with Berzique markers	32 0	402	Ditto " drum	10 0
424	Ditto " " " " " "	29 4	148	Ditto " swedish cushion	6 8

Charlotte Street Steel Pen Works, Birmingham.

SCOTCH TARTAN GOODS—(Continued)

No.	Description	Per dozen.	n.	d.	No.	Description	Per dozen.	n.	d.
430	Measure Spring, English	8	0	0	291	Ice-axe, bottle shape, small	8	0	0
430	Ditto	8	0	0	312	Ditto	8	0	0
106	Metallic Book, small	11	4	0	350	Ditto	8	0	0
107	Ditto	14	0	0	395	Ditto	8	0	0
108	Ditto	18	0	0	391	Ditto	8	0	0
174	Needle Case, bevelled	10	0	0	324	Photo Frame, Oxford	8	0	0
92	Ditto	10	0	0	383	Ditto	8	0	0
223	Ditto	12	0	0	258	Photo Frame, Oxford	8	0	0
150	Needle Hook, small	6	4	0	267	Photo Frame, Oxford	8	0	0
151	Ditto	8	0	0	259	Ditto	8	0	0
152	Ditto	13	0	0	431	Ditto	8	0	0
411	Ditto	12	0	0	432	Ditto	8	0	0
147	Needle Rings, small	16	0	0	433	Ditto	8	0	0
238	Ditto	2	4	0	129	Photo Frame, Oxford	8	0	0
103	Paper Knife, small	2	10	0	177	Ditto	8	0	0
101	Ditto	8	0	0	128	Ditto	8	0	0
101	Ditto	6	0	0	220	Ditto	8	0	0
101	Ditto	10	8	0	219	Ditto	8	0	0
112	Ditto	5	6	0	218	Ditto	8	0	0
113	Ditto	6	8	0	222	Ditto	8	0	0
300	Ditto	8	0	0	217	Ditto	8	0	0
405	Ditto	4	0	0	216	Ditto	8	0	0
375	Ditto	4	0	0	182	Ditto	8	0	0
303	Ditto	9	0	0	272	Ditto	8	0	0
362	Ditto	9	0	0	261	Ditto	8	0	0
338	Ditto	8	8	0	302	Ditto	8	0	0
368	Ditto	10	8	0	408	Ditto	8	0	0
621	Ditto	18	6	0	201	Ditto	8	0	0
3	Ditto	4	0	0	126	Ditto	8	0	0
10	Ditto	7	4	0	225	Ditto	8	0	0
12	Ditto	12	0	0	127	Ditto	8	0	0
13	Ditto	16	8	0	351	Ditto	8	0	0
403	Ditto	18	8	0	290	Ditto	8	0	0
121	Ditto	4	0	0	349	Ditto	8	0	0
120	Ditto	8	0	0	115	Ditto	8	0	0
201	Ditto	8	0	0	349	Ditto	8	0	0
168	Ditto	12	0	0	385	Ditto	8	0	0
247	Ditto	13	4	0	384	Ditto	8	0	0
132	Ditto	18	8	0	298	Ditto	8	0	0
109	Ditto	18	8	0	331	Ditto	8	0	0
281	Ditto	8	0	0	110	Ditto	8	0	0
130	Ditto	13	4	0	110	Ditto	8	0	0
S10	Ditto	13	4	0	110	Ditto	8	0	0
S2	Ditto	1	3	0	240	Ditto	8	0	0
S3	Ditto	1	8	0	240	Ditto	8	0	0
S4	Ditto	2	8	0	240	Ditto	8	0	0
S1	Ditto	2	8	0	367	Ditto	8	0	0
S6	Ditto	8	0	0	196	Ditto	8	0	0
S5	Ditto	12	0	0	196	Ditto	8	0	0
S8	Ditto	8	0	0	143	Ditto	8	0	0
156	Ditto	8	0	0	370	Ditto	8	0	0
310	Ditto	6	0	0					

Charlotte Street Steel Pen Works, Birmingham.

SCOTCH TARTAN GOODS—(Continued)

No.	Description	Per dozen.	n.	d.	No.	Description	Per dozen.	n.	d.
86	Stamp Box, 3 divisions	12	0	0	326	Thumb Case, bevelled	7	4	0
372	Ditto	14	0	0	91	Thermometer, flat	15	0	0
236	Scissor Sloniths, small	3	4	0	420	Ditto	20	0	0
237	Ditto	4	0	0	283	Ditto	21	0	0
230	Silk Winder, large	3	4	0	315	Top, French	15	0	0
89	Ditto	3	4	0	421	Trunk	8	0	0
293	Ditto	4	0	0	191	Trunk	17	0	0
100	Speeclase Case, 6 in.	15	0	0	212	Vinnyrella Box	13	4	0
418	Ditto	16	0	0	116	Wacha Stand	16	0	0
179	Ditto	8	0	0	180	Whistle	3	1	0
301	Tablet	8	0	0	422	Wool Box, large	32	0	0
235	Tattling Shuttle	2	0	0	366	Ditto	15	0	0
297	Teetobum	3	4	0	339	Ditto	21	0	0
163	Toothpowder Box, small	6	0	0	423	Ditto	16	0	0
164	Ditto	8	0	0	207	Waxer	3	1	0
419	Thumb Case, hinged	7	0	0	142	Waxer	3	1	0
179	Ditto	7	4	0	313	Ditto	3	1	0

Terms:

Discount:

Charlotte Street Steel Pen Works, Birmingham.

M. MEYERS, SON, PATENTEES AND MANUFACTURERS

SCOTCH TARTAN GOODS—(Continued)

No.	Description	Per dozen	No.	Description	Per dozen
86	Stamp Box, 3 1/2 in. x 4 1/2 in.	12 0	326	Thimble Case, best	7 0
372	Ditto, 4 1/2 in. x 5 1/2 in.	14 0	91	Thermometer, fine	16 0
235	Stitcher, small	3 4	420	Ditto, obelisk, small	20 0
237	Ditto, large	4 0	283	Ditto, large	24 0
230	Silk Winder, gross	3 4	315	Tops, French	18 0
89	Ditto, pair	3 4	421	Twine box	18 0
229	Ditto, pair	3 4	191	Trunk	17 0
100	Specchio Case, 6 in. x 6 in.	15 0	212	Vannigrette box	13 4
418	Ditto, 6 1/2 in. x 6 1/2 in.	16 0	116	Warch Stencil	16 0
179	Ditto, 8 in. x 8 in.	8 0	180	Whistle	3 4
801	Tablet	8 0	222	Wool Box, large	32 0
235	Tating Shuttle	2 0	856	Ditto, tub shape	16 0
297	Teetum	3 4	839	Ditto, ball	21 0
163	Teetum, Box, small	7 0	423	Ditto, round	16 0
161	Ditto, large	7 0	207	Waxer	3 4
119	Thimble Case, hinged	8 0	142	Waxer box	3 4
179	Ditto, barrel	7 4	313	Ditto, hollow edge	3 4

Terms:

Discount:

(Charlotte Street Steel Pen Works, Birmingham)

1 VOK STILITZ
 23 ROOKFIELD AV.
 LONDON N10 3TS